

Table of Contents

Introduction	4
Instrument Cluster	12
Warning lights and chimes	12
Gauges	17
Entertainment Systems	20
AM/FM stereo	20
AM/FM stereo with CD	22
AM/FM stereo cassette with CD	25
AM/FM stereo with in-dash six CD	30
Climate Controls	37
Manual heating and air conditioning	37
Automatic temperature control	38
Rear window defroster	40
Lights	41
Headlamps	41
Turn signal control	45
Bulb replacement	46
Driver Controls	53
Windshield wiper/washer control	53
Steering wheel adjustment	54
Power windows	56
Mirrors	57
Speed control	59
Message center	63
Locks and Security	73
Keys	73
Locks	73
Anti-theft system	81

Table of Contents

Seating and Safety Restraints	88
Seating	88
Safety restraints	93
Airbags	107
Child restraints	120
Tires, Wheels and Loading	138
Tire information	138
Tire inflation	140
Tire Pressure Monitoring System (TPMS)	153
Vehicle loading	158
Trailer towing	164
Recreational towing	167
Driving	168
Starting	168
Brakes	173
Traction Control™	177
Air suspension	178
Transmission operation	179
Roadside Emergencies	184
Getting roadside assistance	184
Hazard flasher switch	185
Fuel pump shut-off switch	186
Fuses and relays	187
Changing tires	195
Wheel lug nut torque	201
Jump starting	202
Wrecker towing	208
Customer Assistance	210
Reporting safety defects (U.S. only)	216
Reporting safety defects (Canada only)	216
Cleaning	217

Table of Contents

Maintenance and Specifications	224
Engine compartment	226
Engine oil	228
Battery	231
Engine coolant	233
Fuel information	239
Air filter(s)	255
Part numbers	256
Maintenance product specifications and capacities	258
Engine data	261
Accessories	264
Index	266

All rights reserved. Reproduction by any means, electronic or mechanical including photocopying, recording or by any information storage and retrieval system or translation in whole or part is not permitted without written authorization from Ford Motor Company. Ford may change the contents without notice and without incurring obligation.

Copyright © 2009 Ford Motor Company

<https://www.MyCarManual.com>

Introduction

CONGRATULATIONS

Congratulations on acquiring your new Ford. Please take the time to get well acquainted with your vehicle by reading this handbook. The more you know and understand about your vehicle, the greater the safety and pleasure you will derive from driving it.

For more information on Ford Motor Company and its products visit the following website:

- In the United States: www.ford.com
- In Canada: www.ford.ca
- In Australia: www.ford.com.au
- In Mexico: www.ford.com.mx

Additional owner information is given in separate publications.

This *Owner's Guide* describes every option and model variant available and therefore some of the items covered may not apply to your particular vehicle. Furthermore, due to printing cycles it may describe options before they are generally available.

Remember to pass on this *Owner's Guide* when reselling the vehicle. It is an integral part of the vehicle.



WARNING: Fuel pump shut-off switch: In the event of an accident the safety switch will automatically cut off the fuel supply to the engine. The switch can also be activated through sudden vibration (e.g. collision when parking). To reset the switch, refer to the *Fuel pump shut-off switch* in the *Roadside Emergencies* chapter.

SAFETY AND ENVIRONMENT PROTECTION



Warning symbols in this guide

How can you reduce the risk of personal injury to yourself or others? In this guide, answers to such questions are contained in comments highlighted by the warning triangle symbol. These comments should be read and observed.

Introduction

Warning symbols on your vehicle

When you see this symbol, it is imperative that you consult the relevant section of this guide before touching or attempting adjustment of any kind.



Protecting the environment

We must all play our part in protecting the environment. Correct vehicle usage and the authorized disposal of waste, cleaning and lubrication materials are significant steps towards this aim. Information in this respect is highlighted in this guide with the tree symbol.



CALIFORNIA Proposition 65 Warning

 **WARNING:** Engine exhaust, some of its constituents, and certain vehicle components contain or emit chemicals known to the State of California to cause cancer and birth defects or other reproductive harm. In addition, certain fluids contained in vehicles and certain products of component wear contain or emit chemicals known to the State of California to cause cancer and birth defects or other reproductive harm.

PERCHLORATE MATERIAL

Certain components of this vehicle such as airbag modules, seat belt pretensioners, and button cell batteries may contain Perchlorate Material – Special handling may apply for service or vehicle end of life disposal. See www.dtsc.ca.gov/hazardouswaste/perchlorate.

Introduction

BREAKING-IN YOUR VEHICLE

Your vehicle does not need an extensive break-in. Try not to drive continuously at the same speed for the first 1,000 miles (1,600 km) of new vehicle operation. Vary your speed frequently in order to give the moving parts a chance to break in.

Drive your new vehicle at least 1,000 miles (1,600 km) before towing a trailer. For more detailed information about towing a trailer, refer to *Trailer towing* in the *Tires, Wheels and Loading* chapter.

Do not add friction modifier compounds or special break-in oils since these additives may prevent piston ring seating. See *Engine oil* in the *Maintenance and Specifications* chapter for more information on oil usage.

SPECIAL NOTICES

New Vehicle Limited Warranty

For a detailed description of what is covered and what is not covered by your vehicle's New Vehicle Limited Warranty, refer to the *Warranty Guide/Customer Information Guide* that is provided to you along with your *Owner's Guide*.

Notice to owners of Severe Duty vehicles

Before you drive your vehicle, be sure to read the *Severe Duty Owner's Guide* supplement. This book contains important operation and maintenance information.

Special instructions

For your added safety, your vehicle is fitted with sophisticated electronic controls.



WARNING: Please read the section *Airbag Supplemental Restraint System (SRS)* in the *Seating and Safety Restraints* chapter. Failure to follow the specific warnings and instructions could result in personal injury.



WARNING: Front seat mounted rear-facing child or infant seats should **NEVER** be placed in front of an active passenger airbag.

Introduction

Service Data Recording

Service data recorders in your vehicle are capable of collecting and storing diagnostic information about your vehicle. This potentially includes information about the performance or status of various systems and modules in the vehicle, such as engine, throttle, steering or brake systems. In order to properly diagnose and service your vehicle, Ford Motor Company, Ford of Canada, and service and repair facilities may access vehicle diagnostic information through a direct connection to your vehicle when diagnosing or servicing your vehicle. For U.S. only (if equipped), if you choose to use the SYNC® Vehicle Health Report, you consent that certain diagnostic information may also be accessed electronically by Ford Motor Company and Ford authorized service facilities, and that the diagnostic information may be used for any purpose. See your SYNC® supplement for more information.

Event Data Recording

Other modules in your vehicle — event data recorders — are capable of collecting and storing data during a crash or near crash event. The recorded information may assist in the investigation of such an event. The modules may record information about both the vehicle and the occupants, potentially including information such as:

- how various systems in your vehicle were operating;
- whether or not the driver and passenger seatbelts were buckled;
- how far (if at all) the driver was depressing the accelerator and/or the brake pedal;
- how fast the vehicle was traveling; and
- where the driver was positioning the steering wheel.

Introduction

To access this information, special equipment must be directly connected to the recording modules. Ford Motor Company and Ford of Canada do not access event data recorder information without obtaining consent, unless pursuant to court order or where required by law enforcement, other government authorities or other third parties acting with lawful authority. Other parties may seek to access the information independently of Ford Motor Company and Ford of Canada. Please note that once 911 Assist (if equipped) is enabled (set ON), 911 Assist may, through any paired and connected cell phone, disclose to emergency services that the vehicle has been in a crash involving the deployment of an airbag or, in certain vehicles, the activation of the fuel pump shut-off. Certain versions or updates to 911 Assist may also be capable of electronically or verbally disclosing to 911 operators the vehicle location, and/or other details about the vehicle or crash to assist 911 operators to provide the most appropriate emergency services. If you do not want to disclose this information, do not activate the feature. See your SYNC® supplement for more information.

Cell phone use

The use of Mobile Communications Equipment has become increasingly important in the conduct of business and personal affairs. However, drivers must not compromise their own or others' safety when using such equipment. Mobile Communications can enhance personal safety and security when appropriately used, particularly in emergency situations. Safety must be paramount when using mobile communications equipment to avoid negating these benefits.

Mobile Communication Equipment includes, but is not limited to cellular phones, pagers, portable email devices, in-vehicle communications systems, telematics devices and portable two-way radios.



WARNING: Driving while distracted can result in loss of vehicle control, accident and injury. Ford strongly recommends that drivers use extreme caution when using any device that may take their focus off the road. The driver's primary responsibility is the safe operation of their vehicle. Only use cell phones and other devices not essential to the driving task when it is safe to do so.

Introduction

Export unique (Non–United States/Canada) vehicle specific information

For your particular global region, your vehicle may be equipped with features and options that are different from the features and options that are described in this *Owner's Guide*. A market unique supplement may be supplied that complements this book. By referring to the market unique supplement, if provided, you can properly identify those features, recommendations and specifications that are unique to your vehicle. This *Owner's Guide* is written primarily for the U.S. and Canadian Markets. Features or equipment listed as standard may be different on units built for Export. **Refer to this Owner's Guide for all other required information and warnings.**

Introduction

These are some of the symbols you may see on your vehicle.

Vehicle Symbol Glossary

Safety Alert		See Owner's Guide	
Fasten Safety Belt		Airbag - Front	
Airbag - Side		Child Seat Lower Anchor	
Child Seat Tether Anchor		Brake System	
Anti-Lock Brake System		Parking Brake System	
Brake Fluid - Non-Petroleum Based		Parking Aid System	
Stability Control System		Speed Control	
Master Lighting Switch		Hazard Warning Flasher	
Fog Lamps-Front		Fuse Compartment	
Fuel Pump Reset		Windshield Wash/Wipe	
Windshield Defrost/Demist		Rear Window Defrost/Demist	

Introduction

Vehicle Symbol Glossary

Power Windows Front/Rear		Power Window Lockout	
Child Safety Door Lock/Unlock		Interior Luggage Compartment Release	
Panic Alarm		Engine Oil	
Engine Coolant		Engine Coolant Temperature	
Do Not Open When Hot		Battery	
Avoid Smoking, Flames, or Sparks		Battery Acid	
Explosive Gas		Fan Warning	
Power Steering Fluid		Maintain Correct Fluid Level	
Service Engine Soon		Engine Air Filter	
Passenger Compartment Air Filter		Jack	
Check Fuel Cap		Low Tire Pressure Warning	

Instrument Cluster

WARNING LIGHTS AND CHIMES

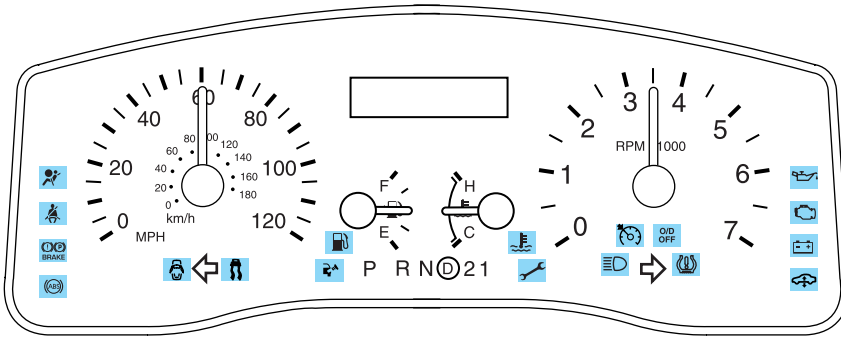

Standard instrument cluster

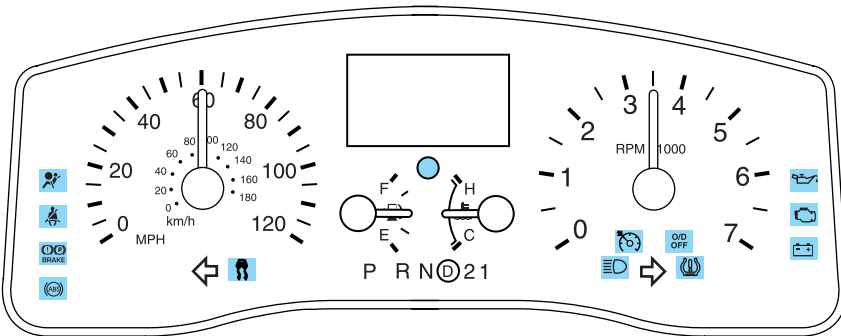

Optional instrument cluster

Warning lights and gauges can alert you to a vehicle condition that may become serious enough to cause expensive repairs. A warning light may illuminate when a problem exists with one of your vehicle's functions. Many lights will illuminate when you start your vehicle to make sure the bulb works. If any light remains on after starting the vehicle, refer to the respective system warning light for additional information.

Instrument Cluster

Service Engine Soon: The *Service Engine Soon* indicator light

illuminates when the ignition is first turned to the on position to check the bulb and to indicate whether the vehicle is ready for Inspection/Maintenance (I/M) testing. Normally, the “Service engine soon” light will stay on until the engine is cranked, then turn itself off if no malfunctions are present. However, if after 15 seconds the “Service engine soon” light blinks eight times, it means that the vehicle is not ready for I/M testing. See the *Readiness for Inspection/Maintenance (I/M) testing* in the *Maintenance and Specifications* chapter.



Solid illumination after the engine is started indicates the On Board Diagnostics System (OBD-II) has detected a malfunction. Refer to *On board diagnostics (OBD-II)* in the *Maintenance and Specifications* chapter. If the light is blinking, engine misfire is occurring which could damage your catalytic converter. Drive in a moderate fashion (avoid heavy acceleration and deceleration) and have your vehicle serviced immediately by your authorized dealer.



WARNING: Under engine misfire conditions, excessive exhaust temperatures could damage the catalytic converter, the fuel system, interior floor coverings or other vehicle components, possibly causing a fire.

Powertrain malfunction indicator (if equipped):

Illuminates when a powertrain fault has been detected. Contact your authorized dealer as soon as possible.



Check fuel cap (if equipped):

Illuminates when the fuel cap may not be properly installed. Continued driving with this light on may cause the Service engine soon warning light to come on. Refer to *Fuel filler cap* in the *Maintenance and Specifications* chapter.



Instrument Cluster

Brake system warning light: To confirm the brake system warning light is functional, it will momentarily illuminate when the ignition is turned to the on position when the engine is not running, or in a position between on and start, or by applying the parking brake when the ignition is turned to the on position. If the brake system warning light does not illuminate at this time, seek service immediately from your authorized dealer. Illumination after releasing the parking brake indicates low brake fluid level and the brake system should be inspected immediately by your authorized dealer.



 **WARNING:** Driving a vehicle with the brake system warning light on is dangerous. A significant decrease in braking performance may occur. It will take you longer to stop the vehicle. Have the vehicle checked by your authorized dealer. Driving extended distances with the parking brake engaged can cause brake failure and the risk of personal injury.

Anti-lock brake system: If the ABS light stays illuminated or continues to flash, a malfunction has been detected, have the system serviced immediately by your authorized dealer. Normal braking is still functional unless the brake warning light also is illuminated.



Airbag readiness: If this light fails to illuminate when the ignition is turned to on, continues to flash or remains on, have the system serviced immediately by your authorized dealer. A chime will sound when there is a malfunction in the indicator light.



Safety belt: Reminds you to fasten your safety belt. A Belt-Minder® chime will also sound to remind you to fasten your safety belt. Refer to the *Seating and Safety Restraints* chapter to activate/deactivate the Belt-Minder® chime feature.



Instrument Cluster

Charging system: Illuminates when the battery is not charging properly. If it stays on while the engine is running, there may be a malfunction with the charging system. Contact your authorized dealer as soon as possible. This indicates a problem with the electrical system or a related component.



Engine oil pressure: Illuminates when the oil pressure falls below the normal range. Check the oil level and add oil if needed. Refer to *Engine oil* in the *Maintenance and Specifications* chapter.



Engine coolant temperature: Illuminates when the engine coolant temperature is high. Stop the vehicle as soon as possible, switch off the engine and let cool. Refer to *Engine coolant* in the *Maintenance and Specifications* chapter.



WARNING: Never remove the coolant reservoir cap while the engine is running or hot.

Traction Control™ : Illuminates when the Traction Control™ system is active. It will be lit for a minimum of four seconds or for the duration of the traction control event, refer to the *Driving* chapter for more information.



Severity indicator (if equipped): Displays the indicated severity color when any of the following warning conditions has occurred:



- Red: Low Oil Pressure, Charge System, Engine Coolant Over Temperature, Door Ajar
- Amber: Low Fuel

Refer to *Message center* in the *Driver Controls* chapter.

Instrument Cluster

Low tire pressure warning:

Illuminates when your tire pressure is low. If the light remains on at start up or while driving, the tire pressure should be checked. Refer to *Inflating your tires* in the *Tires, Wheels and Loading* chapter. When the ignition is first turned to on, the light will illuminate for three seconds to ensure the bulb is working. If the light does not turn on, have the system inspected by your authorized dealer. For more information on this system, refer to *Tire pressure monitoring system (TPMS)* in the *Tires, Wheels and Loading* chapter.

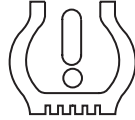

Air suspension (if equipped):

Illuminates when the air suspension is turned off, the load limit is exceeded or the air suspension system requires servicing.

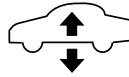

Low fuel (if equipped):

Illuminates when the fuel level in the fuel tank is at or near empty (refer to *Fuel gauge* in this chapter for more information).



O/D off: Illuminates when the overdrive function of the transmission has been turned off; refer to the *Driving* chapter. If the light does not illuminate, have the transmission serviced soon, or damage may occur.



Speed control (if equipped):

Illuminates when the speed control is activated. Turns off when the speed control system is deactivated.



Door ajar (if equipped):

Illuminates when one of the doors is not completely shut and the ignition is turned to on. With the ignition in on position, a tone will sound for one second (if a door is open).



Instrument Cluster

Turn signal: Illuminates when the left or right turn signal or the hazard lights are turned on. If the indicators stay on or flash faster, check for a burned out bulb.



High beams: Illuminates when the high beam headlamps are turned on.



Headlamps on warning chime: Sounds when the headlamps or parking lamps are on, the ignition is off (the key is not in the ignition) and the driver's door is opened.

Key-in-ignition warning chime: Sounds when the key is left in the ignition in the off or accessory position and the driver's door is opened.

GAUGES

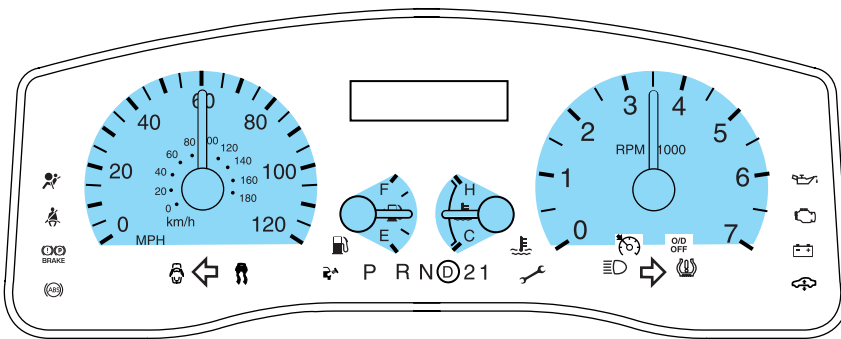

Speedometer: Indicates the current vehicle speed. Refer to the *Message center* in the *Driver Controls* chapter to change your display to a digital speedometer. The digital display is more accurate than the analog gauge and may not match.

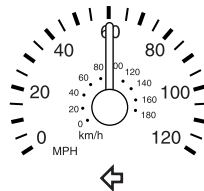

Instrument Cluster

Engine coolant temperature gauge:

Indicates engine coolant temperature. At normal operating temperature, the needle will be in the normal range (between “H” and “C”). **If it enters the red section, the engine is overheating. Stop the vehicle as soon as safely possible, switch off the engine and let the engine cool.**

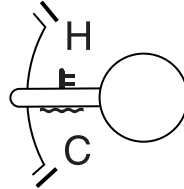

WARNING: Never remove the coolant reservoir cap while the engine is running or hot.

Odometer: Registers the total miles (kilometers) of the vehicle.

- Without Message center

To switch the display from Metric to English, press and hold the button on the cluster for three seconds.



- With Message center

Refer to *Message center* in the *Driver Controls* chapter on how to switch the display from Metric to English and the odometer to the speedometer.

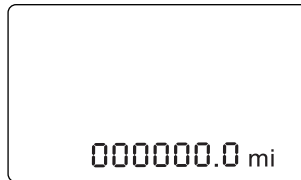

Trip odometer: Registers the miles (kilometers) of individual journeys.

- Without message center

Press and release the button on the cluster to toggle between odometer and trip odometer display. To reset, press the button again until the trip reading is 000000.0 miles.



Instrument Cluster

- With message center

Press and release the message center INFO button until “TRIP” appears in the display (this represents the trip mode). Press the control again to select Trip A and Trip B features. Press and hold the RESET button for two seconds to reset.



Tachometer: Indicates the engine speed in revolutions per minute. Driving with your tachometer pointer continuously at the top of the scale may damage the engine.

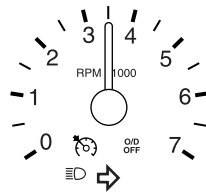

Fuel gauge: Indicates approximately how much fuel is left in the fuel tank (when the ignition is in the on position). The fuel gauge may vary slightly when the vehicle is in motion or on a grade.

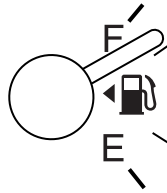

The arrow near the fuel pump icon indicates which side of the vehicle the fuel filler door is located.

Refer to *Filling the tank* in the *Maintenance and Specifications* chapter for more information.

Entertainment Systems

AUDIO SYSTEMS

AM/FM stereo (if equipped)

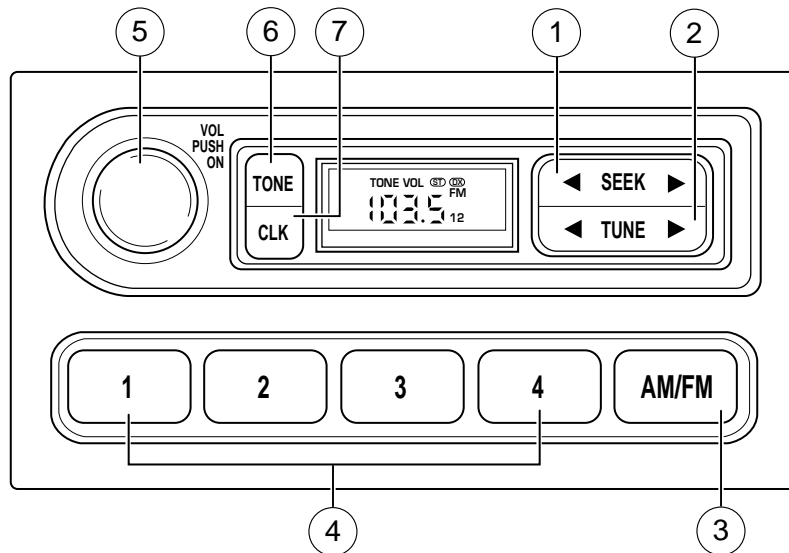

! WARNING: Driving while distracted can result in loss of vehicle control, accident and injury. Ford strongly recommends that drivers use extreme caution when using any device that may take their focus off the road. The driver's primary responsibility is the safe operation of their vehicle. Only use cell phones and other devices not essential to the driving task when it is safe to do so.

1. **Seek:** Press ◀ / ▶ to find the next strong station down/up the frequency band.



2. **Tune:** Press ◀ / ▶ to manually change radio frequency down/up.



Entertainment Systems

3. **AM/FM:** Press to choose a frequency band in radio mode.



4. **Memory preset buttons:** To set a station: Select frequency band AM/FM; tune to a station, press and hold a preset button until sound returns.



5. **Power/volume:** Press to turn ON/OFF; turn to increase or decrease volume levels.



6. **Tone:** Press TONE until the desired level — Bass, Treble, Fade appears on the display. Turn the volume control to raise/lower the levels, or to move the audio sound from the right to left or the front to back (if equipped).

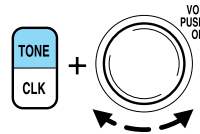

7. **CLK (Clock):** To set the hour, press and hold CLK until CLOCK SET appears in the display. Continue to hold CLK as you press SEEK to decrease ◀ or increase ▶ the hours.



To set the minute, press and hold CLK until CLOCK set appears in the display. Continue to hold CLK as you press TUNE to decrease ◀ or increase ▶ the minutes.

Entertainment Systems

AM/FM Stereo Single CD Premium audio system (if equipped)

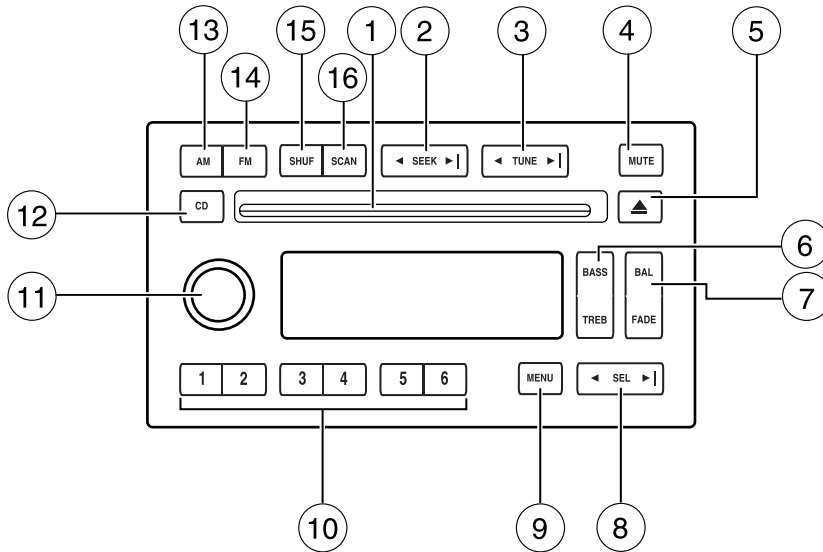

WARNING: Driving while distracted can result in loss of vehicle control, accident and injury. Ford strongly recommends that drivers use extreme caution when using any device that may take their focus off the road. The driver's primary responsibility is the safe operation of their vehicle. Only use cell phones and other devices not essential to the driving task when it is safe to do so.

1. **CD slot:** Insert a CD, label side up. With the ignition on, the radio will begin play when a CD is inserted. If the ignition is off, press CD prior to inserting a disc. Do not force a disc into the system as damage could result.



2. **SEEK:** Press to access the next (▶) or previous (◀) radio station or CD track. Press and hold to advance/reverse in the current CD track.



Entertainment Systems

3. **TUNE:** Press to manually go up (▶) or down (◀) the radio frequency.



4. **MUTE:** Press to mute the playing media. Press again to return to the playing media or turn the volume control to adjust the volume.



5. **Eject:** Press to eject the CD. If the disc is not removed within the allotted time, the system will automatically reload the CD and begin play. **Note:** The eject function will work when the ignition is turned off.



6. **BASS:** Press BASS; then press ◀ SEL ▶ to decrease/increase the level of bass output.

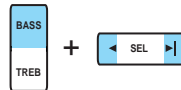

TREB (Treble): Press TREB; then press ◀ SEL ▶ to decrease/increase the level of treble output.

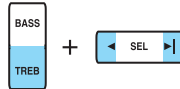

7. **BAL (Balance):** Press BAL; then press ◀ SEL ▶ to shift sound to the left/right speakers.

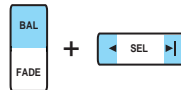

FADE: Press FADE; then press ◀ SEL ▶ to shift sound to the rear/front speakers.

8. **SEL:** Use with Bass, Treble, Balance, Fade and other menu functions.



9. **MENU:** Press MENU to access the following functions:



Autoset: Allows you to set the strongest local radio stations without losing your original manually set preset stations for AM/FM1/FM2. Press MENU until AUTOSSET appears in the display. Press ◀ SEL ▶ to toggle ON/OFF. When the six strongest stations are filled, the station stored in preset 1 will begin playing. If there are less than six strong

Entertainment Systems

stations, the system will store the last one in the remaining presets. When activated, AUTOSET will momentarily appear in the display when any of the preset controls are pressed.

Compression: Brings soft and loud CD passages together for a more consistent listening level when in CD mode. Press MENU until compression status is displayed. Press ◀ SEL ▶ to enable the compression feature when COMPRESS OFF is displayed. Press SEL again to disable the feature when COMPRESS ON is displayed. When activated, the compression icon will appear in the display.

Speed sensitive volume: Radio volume changes automatically and slightly with vehicle speed to compensate for road and wind noise. Recommended level is 1–3. Level 0 turns the feature off and level 7 is the maximum setting.

Press MENU to access and use ◀ SEL ▶ to adjust the volume setting. The level will appear in the display.

Setting the clock: Press MENU until SET HOURS or SET MINUTES is displayed. Press ◀ SEL ▶ to manually decrease/increase the hours/minutes. Press MENU again to disengage clock mode.

Note: The menu selections will remain in the display for approximately 10 seconds, at which time the display will return to the previous mode. You may also exit the menu options by pressing any other audio control.

10. **Memory presets:** To set a station: Select frequency band, tune to a station, press and hold a preset button until sound returns.

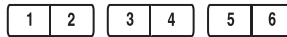

11. **On/Off/Volume:** Push to turn on/off; turn to adjust the volume levels.

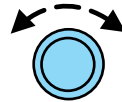

Note: With the ignition turned off, you may press the volume control to momentarily view the clock.

12. **CD:** Press to enter CD mode if a CD is already present in the system. In radio mode, the CD icon will appear in the display if a CD is loaded into the system.

13. **AM:** Press to select the AM frequency.



Entertainment Systems

14. **FM:** Press to select the FM frequency. Press repeatedly to toggle between FM1 and FM2.



15. **SHUF (Shuffle):** Press to play all tracks on the current CD in random order. Press again to stop.



16. **SCAN:** Press SCAN to hear a brief sampling of radio stations or CD tracks. Press again to stop.



Premium/Premium Sound Satellite Compatible AM/FM Stereo Single CD/Cassette system (if equipped)

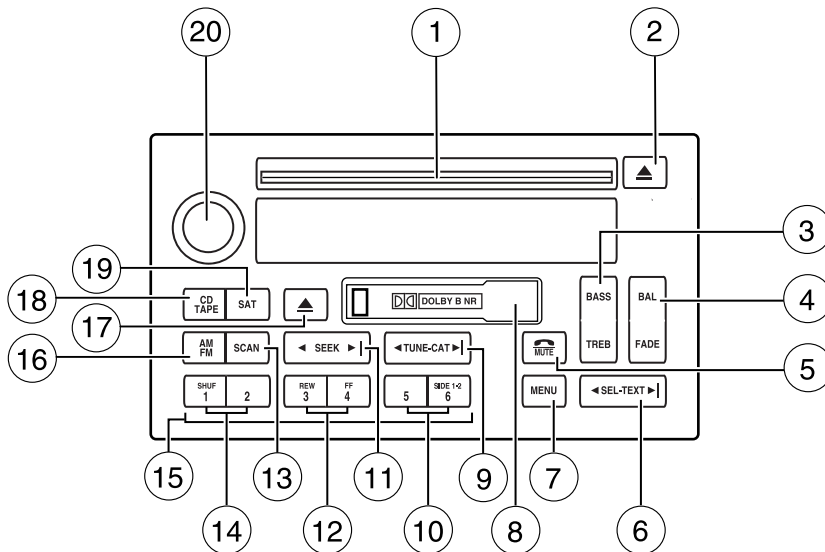

WARNING: Driving while distracted can result in loss of vehicle control, accident and injury. Ford strongly recommends that drivers use extreme caution when using any device that may take their focus off the road. The driver's primary responsibility is the safe operation of their vehicle. Only use cell phones and other devices not essential to the driving task when it is safe to do so.

Entertainment Systems

1. **CD slot:** Insert a CD, label side up. With the ignition on, the radio will begin to play a CD once inserted. With the ignition off, the CD control must be pressed before inserting the disc. Failure may result in damage to the CD and/or audio system.



2. **CD eject:** Press to eject a CD. If the disc is not removed within the allotted time, the system will automatically reload the CD and begin play. **Note:** The eject function will work when the ignition is turned off.



3. **BASS:** Press BASS; then press ◀ SEL-TEXT ▶ to decrease/increase the level of bass output.

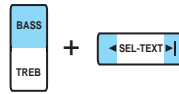

TREB (Treble): Press TREB; then press ◀ SEL-TEXT ▶ to decrease/increase the level of treble output.



4. **BAL (Balance):** Press BAL; then press ◀ SEL-TEXT ▶ to shift sound to the left/right speakers.

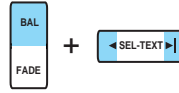

FADE: Press FADE; then press ◀ SEL-TEXT ▶ to shift sound to the rear/front speakers.



5. **Phone/mute:** Press to mute the playing media. Press again to return to the playing media or turn the volume control to adjust the volume.



6. **SEL/TEXT:** Use with Bass, Treble, Balance, Fade and other menu functions.



Entertainment Systems

TEXT: TEXT is only available when equipped with Satellite radio. Your radio may be equipped with Satellite ready capability. The kit to enable Satellite reception is available through your dealer. Detailed Satellite instructions are included with the dealer installed kit. *Check with your authorized dealer for availability.*

7. **MENU:** Press MENU repeatedly to access RDS on/off. Press ◀



SEL-TEXT ▶ to toggle RDS on/off.

Press MENU again to access Program type mode or Show Type/Name mode. (MENU must be pressed within 10 seconds to proceed to the next RDS mode.)

The Federal Communications Commission (FCC) and the Canadian Radio and Telecommunications Commission (CRTC) recommend that FM radio broadcasters use RDS technology to transmit information. FM radio stations are independently operated and individually elect to use RDS technology to transmit station ID and program type as desired.

FIND Program type: Allows you to search RDS-equipped stations for a certain category of music format: Classic, Country, Info, Jazz, Oldies, R&B, Religious, Rock, Soft, Top 40.

With RDS ON, press MENU until the program type menu is displayed.

One of the various program types will appear. Press ◀ SEL-TEXT ▶ to scroll through music types. Press SEEK or SCAN to search for a station playing the requested music category.

Show TYPE: Selects between displaying the station's call letters or music format when RDS is enabled. Press and hold MENU until SHOW XX appears in the display. Press ◀ SEL-TEXT ▶ to select NAME or TYPE.

Compression: Brings soft and loud CD passages together for a more consistent listening level when in CD mode. Press MENU repeatedly until compression status is displayed. Press ◀ SEL-TEXT ▶ control to enable the compression feature when COMPRESS OFF is displayed. Press ◀ SEL-TEXT ▶ control again to disable the feature when COMPRESS ON is displayed. When activated, the compression icon will appear in the display.

Occupancy mode (Available only on Premium Sound audios): Press MENU repeatedly until occupancy mode appears in the display.

Press ◀ SEL-TEXT ▶ to select ALL SEATS, DRIVERS SEATS or REAR SEATS occupancy mode.

Entertainment Systems

Autoset: Allows you to set the strongest local radio stations without losing your original manually set preset stations for AM/FM1/FM2. Press MENU repeatedly until AUTOSSET appears in the display. Press ◀ SEL-TEXT ▶ to toggle ON/OFF. When the six strongest stations are filled, the station stored in preset 1 will begin playing. If there are less than six strong stations, the system will store the last one in the remaining presets. When activated, AUTOSSET will momentarily appear in the display when any of the preset controls are pressed.

Speed sensitive volume: Radio volume changes automatically and slightly with vehicle speed to compensate for road and wind noise. Recommended level is 1–3. Level 0 turns the feature off and level 7 is the maximum setting.

Press MENU repeatedly to access and use ◀ SEL/TEXT ▶ to adjust the volume setting. The level will appear in the display.

Dolby: Works in tape mode to reduce tape noise and hiss. Press MENU until DOLBY XX appears in the display. Press ◀ SEL-TEXT ▶ to toggle ON/OFF.

The Dolby® noise reduction system is manufactured under license from Dolby Laboratories Licensing Corporation. Dolby® and the double-D symbol are registered trademarks of Dolby Laboratories Licensing Corporation.

Setting the clock: Press MENU repeatedly until SET HOURS or SET MINUTES is displayed. Press ◀ SEL-TEXT ▶ to manually decrease/increase the hours/minutes. Press MENU again to disengage clock mode.

Note: The menu selections will remain in the display for approximately 10 seconds, at which time the display will return to the previous mode. You may also exit the menu options by pressing any other audio control.

8. **Cassette:** Insert a cassette facing to the right.

9. **TUNE:** Press to manually go up or down the radio frequency.



CAT: CAT is only available when equipped with Satellite Radio. Your system may be equipped with Satellite ready capability. The kit to enable Satellite reception is available through your dealer. Detailed Satellite instructions are included with the dealer installed kit.

Check with your authorized dealer for availability.

Entertainment Systems

10. **Side 1-2:** Press to access the next side of the cassette tape. The display will indicate whether TAPE 1 or TAPE 2 is playing.



11. **SEEK:** Press to access the next/previous radio station, tape selection or CD track.



12. **REW (Rewind):** Press to rewind in tape or CD mode.



FF (Fast forward): Press to fast forward in tape or CD mode.



13. **SCAN:** Press SCAN to hear a brief sampling of radio stations, selections or CD tracks. Press again to stop.



14. **SHUF (Shuffle):** Press to play the tracks on the current CD in random order. Press again to stop.



15. **Memory presets:** To set a station: Select frequency band, tune to a station, press and hold a preset button until sound returns.



16. **AM/FM:** Press to toggle between AM/FM1/FM2 modes.



17. **Tape eject:** Press to eject the tape.



18. **CD/TAPE:** Press to toggle between CD and TAPE mode. In radio and tape mode, the CD icon will appear in the display if a CD is loaded into the system.



Entertainment Systems

19. **SAT:** Your system may be equipped with Satellite Ready capability. The kit to enable the Satellite reception is available through your dealer. Detailed satellite instructions are included with the dealer installed kit. *Check with your authorized dealer for availability.*



20. **On/Off/Volume:** Push to turn on/off; turn to adjust the volume levels. **Note:** With the ignition turned off, you may press the volume control to momentarily view the clock.

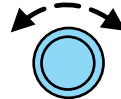

Premium Sound AM/FM Satellite Compatible Stereo In-dash Six CD sound system (if equipped)

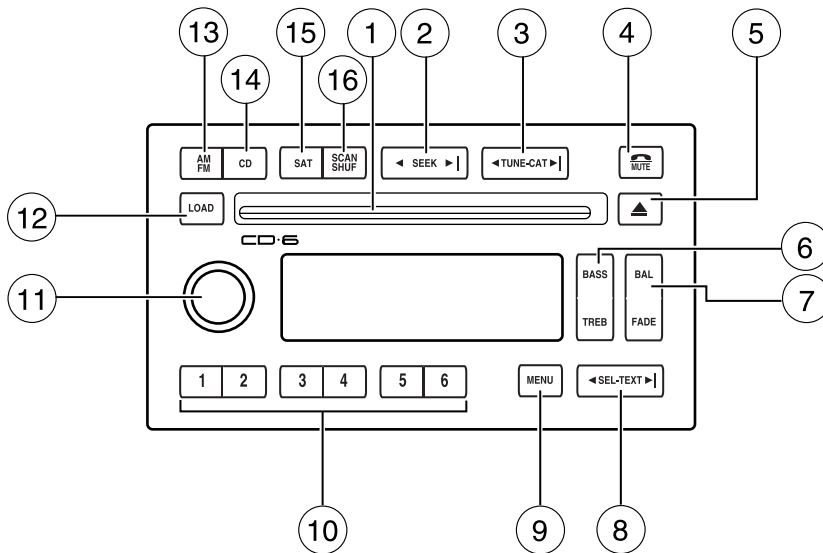

Entertainment Systems



WARNING: Driving while distracted can result in loss of vehicle control, accident and injury. Ford strongly recommends that drivers use extreme caution when using any device that may take their focus off the road. The driver's primary responsibility is the safe operation of their vehicle. Only use cell phones and other devices not essential to the driving task when it is safe to do so.

1. **CD slot:** To insert a CD, press LOAD. Wait to insert a CD until the system displays LOAD CD #. When the system is ready, insert a CD, label side up.

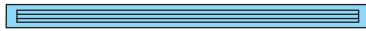

2. **SEEK:** Press to access the next/previous radio station or CD track. Press and hold to advance/reverse in the current CD track.



3. **TUNE/CAT:** Press to manually go up or down the radio frequency.



TEXT is only available when equipped with Satellite radio. Your system may be equipped with Satellite ready capability. The kit to enable Satellite reception is available through your dealer. Detailed Satellite instructions are included with the dealer installed kit. *Check with your authorized dealer for availability.*

4. **MUTE:** Press to mute the playing media. Press again to return to the playing media or turn the volume control to adjust the volume.



5. **Eject:** Press to eject CD(s) when the ignition is on or off. Numbers will illuminate in the display indicating which CD slots are loaded with CDs. To eject a specific CD, press eject and the corresponding preset number. If no preset is selected, the system will eject the currently selected CD. Press and hold to eject all loaded discs.



Note: If the CD is not removed within 15 seconds, the system will reload the disc and begin play if the system is on.

Entertainment Systems

6. **BASS:** Press BASS; then press ◀ SEL-TEXT ▶ to decrease/increase the level of bass output.

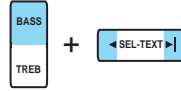

TREB (Treble): Press TREB; then press ◀ SEL-TEXT ▶ to decrease/increase the level of treble output.



7. **BAL (Balance):** Press BAL; then press ◀ SEL-TEXT ▶ to shift sound to the left/right speakers.

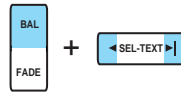

FADE: Press FADE; then press ◀ SEL-TEXT ▶ to shift sound to the rear/front speakers.



8. **SEL-TEXT:** Use with Bass, Treble, Balance, Fade and other menu functions.



TEXT: TEXT is only available when equipped with Satellite radio. Your system may be equipped with Satellite ready capability. The kit to enable Satellite reception is available through your dealer. Detailed Satellite instructions are included with the dealer installed kit. *Check with your authorized dealer for availability.*

9. **MENU:** Press MENU repeatedly to access RDS on/off.



Use ◀ SEL-TEXT ▶ to toggle

RDS on/off. Press MENU again to access Program type mode or Show Type mode. (MENU must be pressed within 10 seconds to proceed to the next RDS mode.)

The Federal Communications Commission (FCC) and the Canadian Radio and Telecommunications Commission (CRTC) recommend that FM radio broadcasters use RDS technology to transmit information. FM radio stations are independently operated and individually elect to use RDS technology to transmit station ID and program type as desired.

Entertainment Systems

FIND Program type: Allows you to search RDS-equipped stations for a certain category of music format: Classic, Country, Info, Jazz, Oldies, R&B, Religious, Rock, Soft, Top 40.

With RDS ON, press MENU until the program type menu is displayed.

One of the various program types will appear. Press ◀ SEL-TEXT ▶ to scroll through music types. Press SEEK or SCAN to search for a station playing the requested music category.

Show TYPE: Selects between displaying the station's call letters or music format when RDS is enabled. Press MENU until SHOW XX appears in the display. Press to select NAME or TYPE.

Compression: Brings soft and loud CD passages together for a more consistent listening level when in CD mode. Press MENU until compression status is displayed. Press ◀ SEL-TEXT ▶ to enable the compression feature when COMPRESS OFF is displayed. Press the SEL control again to disable the feature when COMPRESS ON is displayed. When activated, the compression icon will illuminate in the display.

Occupancy mode (Available on Premium Sound audios only): Press MENU until occupancy mode appears in the display. Press ◀ SEL-TEXT ▶ to select ALL SEATS, DRIVERS SEAT or REAR SEATS occupancy mode.

Autoset: Allows you to set the strongest local radio stations without losing your original manually set preset stations for AM/FM1/FM2. Press MENU until AUTOSSET appears in the display. Press ◀ SEL-TEXT ▶ to toggle ON/OFF. When the six strongest stations are filled, the station stored in preset 1 will begin playing. If there are less than six strong stations, the system will store the last one in the remaining presets. When activated, AUTOSSET will appear in the display when any of the preset controls are pressed.

Speed sensitive volume: Radio volume changes automatically and slightly with vehicle speed to compensate for road and wind noise. Recommended level is 1–3. Level 0 turns the feature off and level 7 is the maximum setting.

Press MENU to access and use ◀ SEL-TEXT ▶ to adjust the volume setting. The level will appear in the display.

Setting the clock: Press MENU until SELECT HOUR or SELECT MINS is displayed. Press ◀ SEL-TEXT ▶ to increase/decrease the hours/minutes. Press MENU again to disengage clock mode.

Entertainment Systems

10. **Memory presets:** To set a station: Select frequency band, tune to a station, press and hold a preset button until sound returns. In CD mode, press to select a specific CD to play.

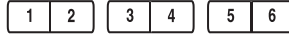

11. **On/Off/Volume:** Push to turn on/off; turn to adjust the volume levels.

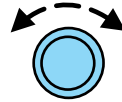

Note: With the ignition off, you may press the volume control to momentarily view the clock.

12. **LOAD:** Press to load a CD. Press LOAD and a specific preset to load in that particular slot. Available slots are indicated by small flashing indicators in the display. When the system is ready to accept a disc, LOAD CD X will appear in the display. Load the CD. Press and hold to autoloading up to 6 discs.



Note: Ensure that the system is ready to accept the CD. Do not force the disc into the CD slot as damage could result.

13. **AM/FM:** Press repeatedly to toggle between AM/FM1/FM2 mode.



14. **CD:** Press to enter CD mode. Press CD and a preset to select a specific CD to play.



15. **SAT:** Your system may be equipped with Satellite Ready capability. The kit to enable the Satellite reception is available through your authorized dealer. Detailed satellite instructions are included with the dealer installed kit.

Check with your authorized dealer for availability.

16. **SHUF (Shuffle) /SCAN:** Press SCAN to hear a brief sampling of radio stations or CD tracks on the current CD. Press again to stop.

SHUF (Shuffle): Press and hold to play the CD tracks in random order for the CD currently being played. Press again to stop.

Entertainment Systems

GENERAL AUDIO INFORMATION

Radio frequencies: AM and FM frequencies are established by the Federal Communications Commission (FCC) and the Canadian Radio and Telecommunications Commission (CRTC). Those frequencies are:

AM - 530, 540–1700, 1710 kHz

FM- 87.7, 87.9–107.7, 107.9 MHz

Radio reception factors: There are three factors that can affect radio reception:

- Distance/strength: The further you travel from a station, the weaker the signal and the weaker the reception.
- Terrain: Hills, mountains, tall buildings, power lines, electric fences, traffic lights and thunderstorms can interfere with your reception.
- Station overload: When you pass a broadcast tower, a stronger signal may overtake a weaker one and play while the weak station frequency is displayed.

Cassette player care:

- Use only cassettes that are 90 minutes long or less.
- Tighten very loose tapes by inserting a finger or pencil into the hole and turning the hub.
- Remove loose labels before inserting tapes.
- Allow tapes which have been subjected to extreme heat, humidity or cold to reach a moderate temperature before playing.
- Clean the cassette player head with a cassette cleaning cartridge after 10–12 hours of play to maintain good sound/operation.

Don't:

- Expose tapes to direct sunlight, extreme humidity, heat or cold.
- Leave tapes in the cassette player for a long time when not being played.

Entertainment Systems

CD/CD player care:

Do:

- Handle discs by their edges only. Never touch the playing surface.
- Inspect discs before playing. Clean only with an approved CD cleaner and wipe from the center out.

Don't:

- Expose discs to direct sunlight or heat sources for extended periods of time.
- Clean using a circular motion.

CD units are designed to play commercially pressed 4.75 in (12 cm) audio compact discs only. Due to technical incompatibility, certain recordable and re-recordable compact discs may not function correctly when used in Ford CD players. Dirty, warped or damaged CDs, irregular shaped CDs, CDs with a scratch protection film attached, and CDs with homemade paper (adhesive) labels should not be inserted into the CD player. The label may peel and cause the CD to become jammed. It is recommended that homemade CDs be identified with permanent felt tip marker rather than adhesive labels. Ballpoint pens may damage CDs. Please contact your authorized dealer for further information.

Audio system warranty and service: Refer to the *Warranty Guide/Customer Information Guide* for audio system warranty information. If service is necessary, see your dealer or qualified technician.

Climate Controls

MANUAL HEATING AND AIR CONDITIONING SYSTEM (IF EQUIPPED)

1. **Fan speed adjustment:** Controls the volume of air circulated in the vehicle.

2. **Temperature selection:** Controls the temperature of the airflow in the vehicle.

3. **Air flow selections:** Controls the direction of the airflow in the vehicle. See the following for a brief description on each control.

MAX A/C: Uses recirculated air to cool the vehicle. Air flows from the instrument panel vents only. This mode will help prevent unpleasant odors from entering the vehicle.

NORM A/C: Uses outside air to cool the vehicle. Air flows from the instrument panel vents only.

VENT: Distributes outside air through the instrument panel vents.

OFF: Outside air is shut out and the fan will not operate.

FLOOR: Distributes outside air through the floor vents.

MIX: Distributes outside air through the windshield defroster vents, floor vents and side window demisters.

 : Distributes outside air through the windshield defroster vents and the side window demisters.

Operating tips

- To reduce fog build up on the windshield during humid weather, place the air flow selector in the  position.
- To reduce humidity build up inside the vehicle: do not drive with the air flow selector in OFF or MAX A/C.
- Under normal weather conditions, do not leave the air flow selector in MAX A/C or OFF when the vehicle is parked. This allows the vehicle to “breathe” using the outside air inlet vents.
- Do not put objects under the front seats that will interfere with the airflow to the back seats.
- Remove any snow, ice or leaves from the air intake area at the base of the windshield.

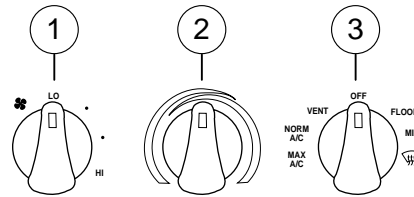

Climate Controls

During extreme high ambient temperatures when idling stationary for extended periods of time in gear, it is recommended to run the A/C in the MAX A/C position reduce blower fan speed from the highest setting and put the vehicle's transmission into the park gear position to continue to receive cool air from your A/C system.

To aid in side window defogging/demisting in cold weather:

1. Select NORM A/C.
 2. Adjust the temperature control to maintain comfort.
 3. Set the fan speed to HI.
 4. Direct the outer instrument panel vents towards the side windows.
- To increase airflow to the outer instrument panel vents, close the vents located in the middle of the instrument panel.

ELECTRONIC AUTOMATIC TEMPERATURE CONTROL (EATC) SYSTEM (IF EQUIPPED)

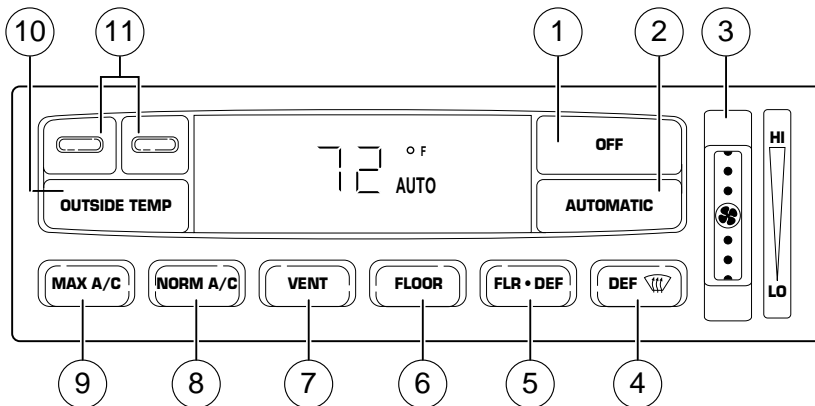

1. **OFF:** Outside air is shut out and the fan will not operate.



2. **AUTOMATIC:** Press AUTOMATIC and select the desired temperature using the temperature controls. The system will automatically determine fan speed, airflow location, and outside or recirculated air to heat or cool the vehicle to the selected temperature. The fan speed will remain automatic unless the thumbwheel is turned all the way to LO.



Climate Controls

3. **Fan speed:** Turn to manually increase or decrease fan speed.



4. **Defrost:**  Distributes outside air through the windshield defroster vents and the side window demisters.

5. **Floor/defrost:** Distributes outside air through the windshield defroster vents, floor vents and the side window demisters.

6. **Floor:** Distributes outside air through the floor vents.

7. **Vent:** Distributes outside air through the instrument panel vents.

8. **Norm A/C:** Uses outside air to cool the vehicle. Air flows from the instrument panel vents only.

9. **Max A/C:** Uses recirculated air to cool the vehicle. Air flows from the instrument panel vents only. This mode will help prevent unpleasant odors from entering the vehicle.

10. **Outside Temp:** Press to display the outside temperature. It will remain in the display until pressed again. The temperature will be most accurate when the vehicle is in motion.



11. **Temperature control:** Press this control to select the temperature. The display window indicates the selected temperature.

Fahrenheit/Celsius temperature: Press MAX A/C and DEF  simultaneously to toggle between Fahrenheit and Celsius temperature. The set point temperatures in Celsius will be displayed in half-degree increments.

Operating tips

- To reduce fog build up on the windshield during humid weather, place the air flow selector in the  position.
- To reduce humidity build up inside the vehicle: do not drive with the air flow selector in OFF or MAX A/C.
- Under normal weather conditions, do not leave the air flow selector in MAX A/C or OFF when the vehicle is parked. This allows the vehicle to “breathe” using the outside air inlet vents.
- Do not put objects under the front seats that will interfere with the airflow to the back seats.

Climate Controls

- Remove any snow, ice or leaves from the air intake area at the base of the windshield.

During extreme high ambient temperatures when idling stationary for extended periods of time in gear, it is recommended to run the A/C in the MAX A/C position reduce blower fan speed from the highest setting and put the vehicle's transmission into the park gear position to continue to receive cool air from your A/C system.

To aid in side window defogging/demisting in cold weather:

1. Select NORM A/C.
2. Adjust the temperature control to maintain comfort.
3. Set the fan speed to HI.
4. Direct the outer instrument panel vents towards the side windows.

To increase airflow to the outer instrument panel vents, close the vents located in the middle of the instrument panel.

REAR WINDOW DEFROSTER

The rear defroster control is located on the instrument panel.

Press the rear defroster control to clear the rear window of thin ice and fog. A small LED will illuminate when the rear defroster is activated.

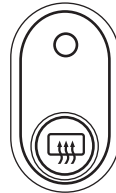

The ignition must be in the on position to operate the rear window defroster.

The defroster turns off automatically after a predetermined amount of time or when the ignition is turned off. To manually turn off the defroster, press the control again.

Activating the rear window defroster will also activate the heated mirrors (if equipped). For more information refer to *Heated outside mirrors* in the *Driver Controls* chapter.

Do not use razor blades or other sharp objects to clean the inside of the rear window or to remove decals from the inside of the rear window. This may cause damage to the heated grid lines and will not be covered by your warranty.

Lights

HEADLAMP CONTROL ☼

○ Turns the lamps off.

☼ Turns on the parking lamps, instrument panel lamps, license plate lamps and tail lamps.

☼ Turns the headlamps on.

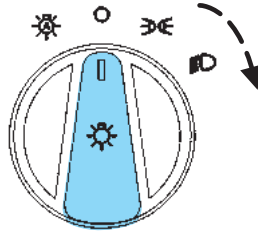

Autolamp control (if equipped) ☼

The autolamp system provides light sensitive automatic on-off control of the exterior lights normally controlled by the headlamp control.

The autolamp system also keeps the lights on for a predetermined period of time after the ignition switch is turned to off. The delay period can be adjusted up to a maximum of approximately three minutes in duration.

- To turn autolamps on, rotate the control counterclockwise to the next position from off.
- To turn autolamps off, rotate the control clockwise.

The headlamps will also turn on when the wipers are turned on.

To change the duration of the autolamp delay, perform the following sequence:

Note: Steps 2 through 5 must be carried out within a 10 second period.

1. Start with the ignition switch in the off position and the headlamp switch in the autolamp position.
 2. Place the headlamp switch in the off position.
 3. Place the ignition switch in the on position and then back to off.
 4. Place the headlamp switch in the autolamp position.
- At this point, the exterior lamps turn on.

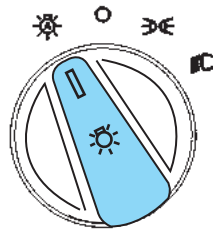

Lights

5. At the desired autolamp time delay, place the headlamp switch in the off position.

- At this point, the exterior lamps turn off and the time delay is set.

High beams

Push the lever toward the instrument panel to activate. Pull the lever towards you to deactivate.

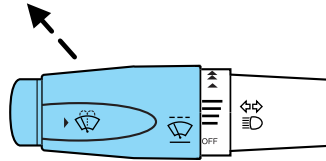

Flash to pass

Pull toward you slightly to activate and release to deactivate.

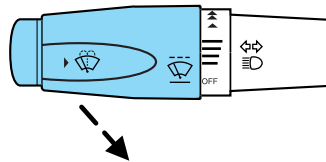

Daytime running lamps (DRL) (if equipped)

Turns the headlamps on with a reduced output. To activate:

- the key must be in the on position,
- the headlamp control is in the off or  position.
- the vehicle is not in P (Park)



WARNING: Always remember to turn on your headlamps at dusk or during inclement weather. The Daytime Running Light (DRL) System does not activate your tail lamps and generally may not provide adequate lighting during these conditions. Failure to activate your headlamps under these conditions may result in a collision.

PANEL DIMMER CONTROL

Use to adjust the brightness of the instrument panel during headlamp and parking lamp operation.

- Rotate the thumbwheel from left to right to brighten the instrument panel.
- Rotate the thumbwheel from right to left to dim the instrument panel.

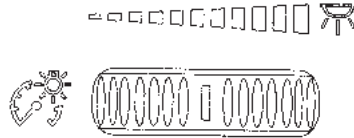

Dome lamp control

The panel dimmer control also controls the dome lamp operation.

- Rotate the thumbwheel fully to the right, past detent, to activate the dome lamp.
- In order to turn off the dome lamp, rotate the thumbwheel to the left.

AIMING THE HEADLAMPS

The headlamps on your vehicle are properly aimed at the assembly plant. If your vehicle has been in an accident, the alignment of your headlamps should be checked by your authorized dealer.

Headlamp aim adjustment

The headlamps are designed to be mechanically aimed, but can also be aimed visually by doing the following:

1. Park the vehicle directly in front of a wall or screen on a level surface, approximately 25 feet (7.6 meters) away. Check your headlamp alignment at night or in a dark area so that you can see the headlamp beam pattern.

Lights

- (1) 8 feet (2.4 meters)
- (2) Center height of lamp to ground
- (3) 25 feet (7.6 meters)
- (4) Horizontal reference line
- (5) Center of headlamps
- (6) Center line of the vehicle

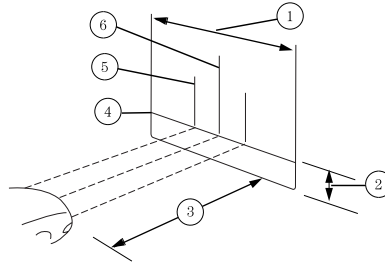

2. The center of the headlamp is marked either on the lens (a circle or cross marker) or on the bulb shield, internal to the lamp (mark or feature). Measure the height from the center of your headlamp to the ground (2) and mark an 8 foot (2.4 meter) long horizontal line on the wall or screen (1) at this height (masking tape works well).

3. Turn on the low beam headlamps and open the hood.

4. Locate the high intensity area of the beam pattern and place the top edge of the intensity zone even with the horizontal reference line (4). If the top edge of the high intensity area is not even with the horizontal line, follow the next step to adjust it.

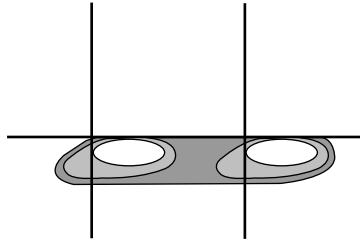

5. Locate the vertical adjuster for each headlamp. Adjust the aim by turning the adjuster control either clockwise (to adjust down) or counterclockwise (to adjust up).

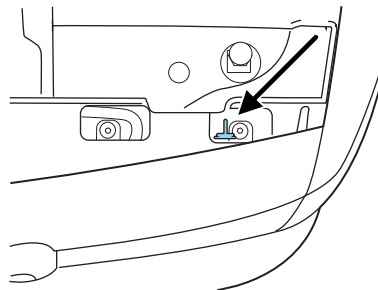

6. In addition to the horizontal line marked in step 2, a pair of vertical lines (5) must be marked at the center line of the headlamps on the wall or screen.

7. On the wall or screen, locate the high intensity area of the beam pattern. The left edge of the high intensity area should be even with the vertical line corresponding to the headlamp under adjustment. If the left edge of the high intensity area is not even with the vertical line, follow the next step to adjust it.

Lights

8. Locate the horizontal adjuster for each headlamp. Turn it clockwise or counterclockwise, to place the left edge of the high intensity area even with the vertical line corresponding to the headlamp under adjustment.

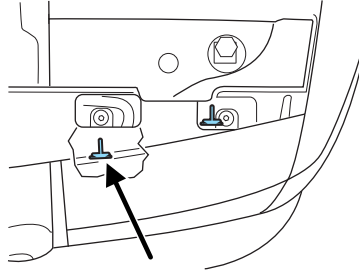

TURN SIGNAL CONTROL ⇄

- Push down to activate the left turn signal.
- Push up to activate the right turn signal.

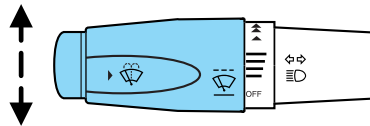

The flash rate of the turn signal will speed up considerably if the left or right turn lamp bulb (front or rear) is burned out.

INTERIOR LAMPS

Map/courtesy lamps

The courtesy lamps light when:

- any door is opened.
- the instrument panel dimmer switch is rotated past the detent.
- the unlock control of the remote entry controls is pressed and the ignition is off.

The reading lamps can be turned on by pressing the rocker controls next to each lamp.

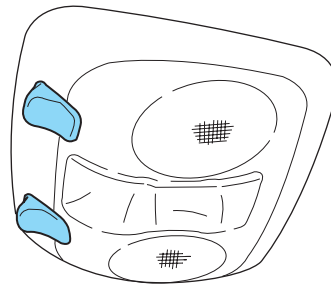

If equipped with remote keyless entry, the courtesy lamp will illuminate whenever any door is opened and will remain on for 25 seconds after the door is shut or when the ignition is turned to the on position.

Lights

Rear courtesy/reading lamps (if equipped)

Rotate the lens to illuminate the lamp. With the lens in the flat position, the courtesy lamp lights when:

- Any door is opened.
- The panel dimmer thumbwheel is rotated fully to the right past detent.

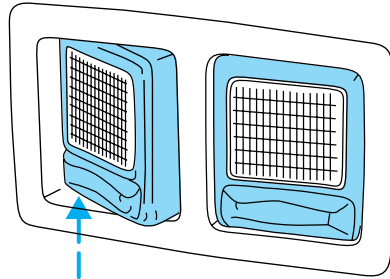

BULB REPLACEMENT

Lamp assembly condensation

Exterior lamps are vented to accommodate normal changes in pressure. Condensation can be a natural by-product of this design. When moist air enters the lamp assembly through the vents, there is a possibility that condensation can occur when the temperature is cold. When normal condensation occurs, a thin film of mist can form on the interior of the lens. The thin mist eventually clears and exits through the vents during normal operation. Clearing time may take as long as 48 hours under dry weather conditions.

Examples of acceptable condensation are:

- Presence of thin mist (no streaks, drip marks or droplets)
- Fine mist covers less than 50% of the lens

Examples of unacceptable moisture (usually caused by a lamp water leak) are:

- Water puddle inside the lamp
- Large water droplets, drip marks or streaks present on the interior of the lens

Take your vehicle to dealer for service if any of the above conditions of unacceptable moisture are present.

Using the right bulbs

Replacement bulbs are specified in the chart below. Headlamp bulbs must be marked with an authorized "D.O.T." for North America and an "E" for Europe to ensure lamp performance, light brightness and pattern and safe visibility. The correct bulbs will not damage the lamp assembly or void the lamp assembly warranty and will provide quality bulb burn time.

Lights

Function	Trade Number
Headlamp	9007
Park lamp and turn lamp (front)	3457 AK (amber)
Side marker (front)	194 AK (amber)
Tail, stop, turn (rear)	3157K
Side marker (rear)	194
Backup lamp	3156K
License plate lamp	168
High-mount brakelamp	912
Luggage compartment lamp	212-2
Rear reading lamp	578
Map lamp	906
Dual floorwell lamp	906
Glove compartment	168
Visor vanity lamp - Slide on Rail system (SOR)	A6224PF
All replacement bulbs are clear in color except where noted.	
To replace all instrument panel lights - see your authorized dealer.	

Replacing interior bulbs

Check the operation of all bulbs frequently.

Replacing exterior bulbs

Check the operation of all bulbs frequently.

Replacing headlamp bulbs

To remove the headlamp bulb:

1. Make sure the headlamp switch is in the off position, then open the hood.
2. Remove the radiator cover by turning the three knobs to the unlock position.

Lights

3. Remove the two retainers and pull headlamp assembly forward to expose bulb.

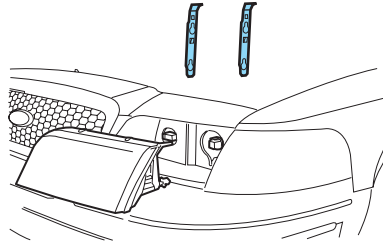

4. Disconnect the electrical connector from the bulb by pulling rearward.

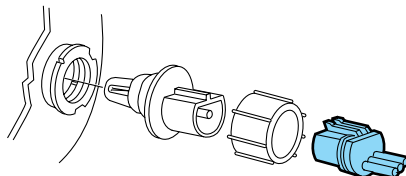

5. Remove the bulb retaining ring by rotating it counterclockwise (when viewed from the rear) to free it from the bulb socket, and slide the ring off the plastic base. Keep the ring to retain the new bulb.

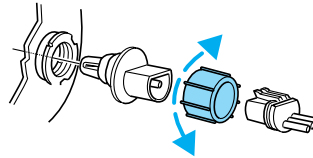

6. Without turning, remove the old bulb from the lamp assembly by gently pulling it straight back out of the lamp assembly.

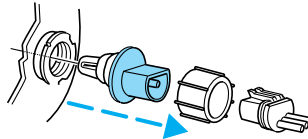

To install the new bulb:

⚠ WARNING: Handle a halogen headlamp bulb carefully and keep out of children's reach. Grasp the bulb only by its plastic base and do not touch the glass. The oil from your hand could cause the bulb to break the next time the headlamps are operated.

Note: If the bulb is accidentally touched, it should be cleaned with rubbing alcohol before being used.

Lights

1. With the flat side of the new bulb's plastic base facing upward, insert the glass end of the bulb into the lamp assembly. Turn the bulb left or right to align the grooves in the plastic base with the tabs in the lamp assembly. When the grooves are aligned, push the bulb into the lamp assembly until the plastic base contacts the rear of the lamp assembly.
2. Install the bulb retaining ring over the plastic base until it contacts the rear of the socket by rotating it clockwise until you feel a "stop."
3. Connect the electrical connector into the rear of the plastic base until it snaps, locking it into position.
4. Install the headlamp assembly with two retainers.
5. Install the radiator cover locking it in place with three knobs.
6. Turn the headlamps on and make sure they work properly. If the headlamp was correctly aligned before you changed the bulb, you should not need to align it again.

Replacing front parking/turn signal lamp bulbs

To remove the front parking/turn signal lamp bulbs:

1. Make sure headlamp switch is in the off position, then open the hood.
2. Remove the radiator cover by turning the three knobs to the unlock position.
3. Remove two retainers and pull headlamp assembly forward to expose bulb.
4. Remove the bulb socket by rotating it counterclockwise, then pulling it out of the lamp assembly.

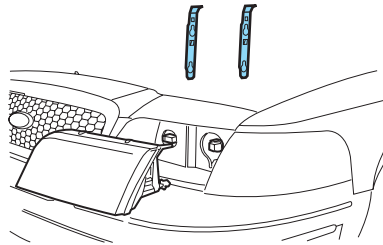

5. Pull the bulb from the socket and push in the new bulb.
6. Install the bulb socket into the lamp assembly by rotating it clockwise.

To complete installation, follow the removal procedure in reverse order.

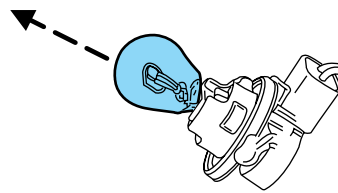

Lights

Replacing front sidemarket bulb

To remove the front side marker bulb:

1. Make sure headlamp switch is in the off position, then open the hood.
2. Remove the radiator cover by turning the three knobs to the unlock position.
3. Remove the screw from the outside of the lamp.
4. Remove the nut from inside the lamp and pull the lamp assembly away from the vehicle.

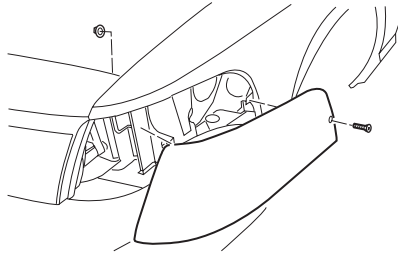

5. Rotate the bulb socket counterclockwise and remove from lamp assembly.
6. Carefully pull bulb straight out of the socket and push in the new bulb until it snaps, locking it into position.
7. To complete installation, follow the removal procedure in reverse order.

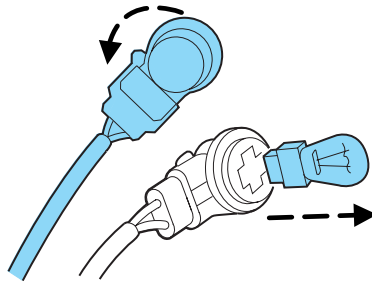

Replacing tail/brake/turn signal lamp bulbs

The tail lamp and brake/turn signal lamp bulbs are located in the tail lamp assembly. Follow the same steps to replace either bulb.

Lights

1. Make sure the headlamp switch is in the off position, then open the trunk and remove the pin-type retainer.
2. Carefully pull the carpet away to expose the lamp assembly hardware.
3. Remove three nuts and the lamp assembly from the vehicle.
4. Remove the bulb socket by rotating it counterclockwise, then pulling it out of the lamp assembly.

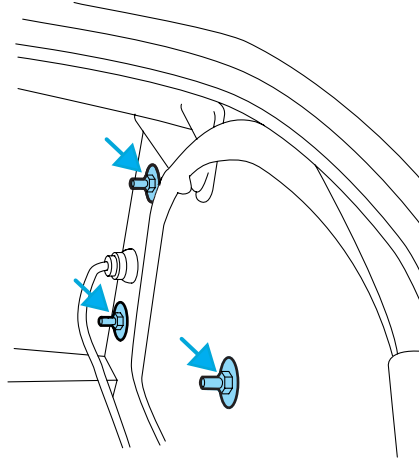

5. Pull the bulb from the socket and push in the new bulb.
6. Install the bulb socket into the lamp assembly by rotating it clockwise.
7. Install the lamp assembly on the vehicle with three nuts ensuring the nuts are flush with the body to prevent water from entering the trunk.
8. Carefully push the carpet back in to place and install the pin-type retainer.

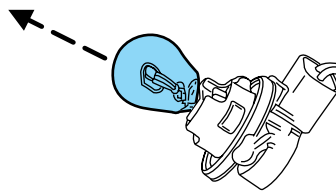

Replacing license plate lamp bulbs

1. Make sure headlamp switch is in the off position, then remove two screws, grommets and the license plate lamp assembly from the trunk lid.
2. Carefully pull the bulb from the socket and push in the new bulb.

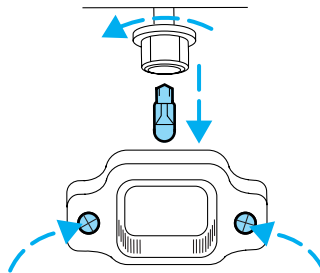

Lights

3. Install the lamp assembly on trunk lid with two grommets, ensuring the grommets are pushed all the way into the trunk lid and secure with two screws.

Replacing backup lamp bulbs

1. Open trunk and remove bulb socket from the trunk lid by turning counterclockwise.
2. Pull the bulb straight out of the socket and push in the new bulb.
3. Install the bulb socket in trunk lid by turning clockwise.

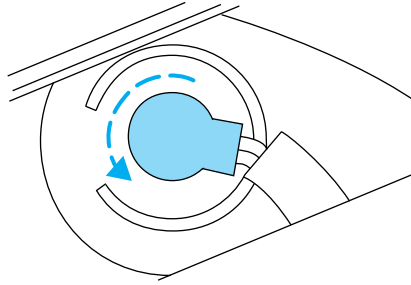

Replacing high-mount brakelamp bulbs

1. Remove two screws from the lamp assembly.
2. Carefully lift the lamp assembly up for access to the bulbs.

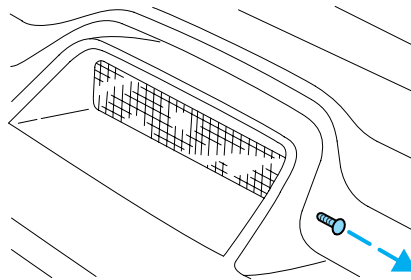

3. Carefully pull the bulb socket out of the lamp assembly.
 4. Pull the bulb straight out of the socket and push in the new bulb.
- To install, reverse the removal procedure.

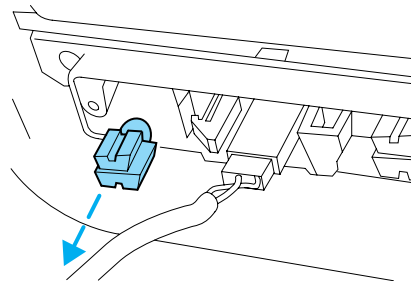

Driver Controls

MULTI-FUNCTION LEVER

Windshield wiper: Rotate the end of the control away from you to increase the speed of the wipers; rotate towards you to decrease the speed of the wipers.

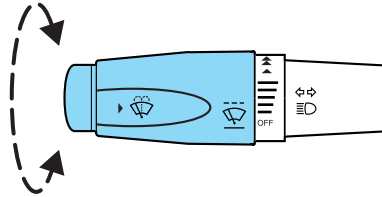

Windshield washer: Push the end of the stalk:

- briefly: causes a single swipe of the wipers without washer fluid.
- a quick push and hold: the wipers will swipe three times with washer fluid.
- a long push and hold: the wipers and washer fluid will be activated for up to five seconds.

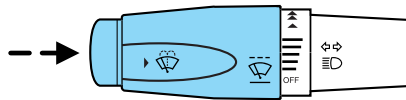

Courtesy wipe feature: One extra wipe will happen a few seconds after washing the front window to clear any water that is dripping down from the top of the windshield caused by the washing.

Note: Do not operate the washer when the washer reservoir is empty. This may cause the washer pump to overheat. Check the washer fluid level frequently. Do not operate the wipers when the windshield is dry. This may scratch the glass, damage the wiper blades and cause the wiper motor to burn out. Before operating the wiper on a dry windshield, always use the windshield washer. In freezing weather, be sure the wiper blades are not frozen to the windshield before operating the wipers.

Windshield wiper/washer features

When the windshield wipers are turned on during daylight, and the headlamp control is in the autolamp position, the exterior lamps will turn on after a brief delay and will remain on until the wipers are turned off.

Driver Controls

TILT STEERING WHEEL

To adjust the steering wheel:

1. Pull and hold the steering wheel release control toward you.
2. Move the steering wheel up or down until you find the desired location.
3. Release the steering wheel release control. This will lock the steering wheel in position.

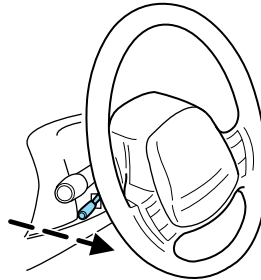

WARNING: Never adjust the steering wheel when the vehicle is moving.

ILLUMINATED VISOR MIRROR (IF EQUIPPED)

Lift the mirror cover to turn on the visor mirror lamps.

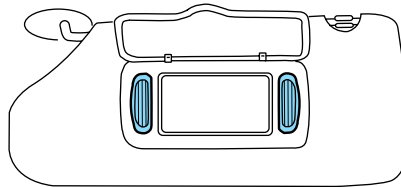

Slide on rod feature (if equipped)

Rotate the visor towards the side window and extend it rearward for additional sunlight coverage.

Note: To stow the visor back into the headliner, visor must be retracted before moving it back towards the windshield.

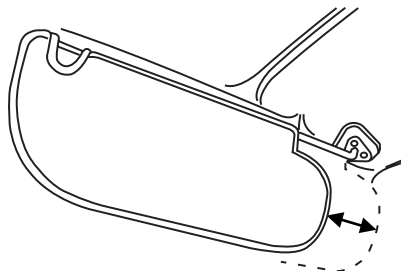

Driver Controls

CENTER CONSOLE (IF EQUIPPED)

Your vehicle may be equipped with a variety of console features. These include:

- Utility compartment
- Power point (inside storage bin)
- Cupholders
- Air vents to the rear seating positions (heat only)



WARNING: Use only soft cups in the cupholder. Hard objects can injure you in a collision.

AUXILIARY POWER POINT (12VDC)

Power outlets are designed for accessory plugs only. Do not insert any other object in the power outlet as this will damage the outlet and blow the fuse. Do not hang any type of accessory or accessory bracket from the plug. Improper use of the power outlet can cause damage not covered by your warranty.

The auxiliary power point is located under the cup holder and ashtray drawer in the center stack. The auxiliary power point for five passenger vehicles is located in the floor console storage bin.

Do not use the power point for operating the cigarette lighter element (if equipped).

To prevent the fuse from being blown, do not use the power point(s) over the vehicle capacity of 12 VDC/180W. If the power point or cigar lighter socket is not working, a fuse may have blown. Refer to *Fuses and relays* in the *Roadside Emergencies* chapter for information on checking and replacing fuses.

To have full capacity usage of your power point, the engine is required to be running to avoid unintentional discharge of the battery. To prevent the battery from being discharged:

- do not use the power point longer than necessary when the engine is not running,
- do not leave battery chargers, video game adapters, computers and other devices plugged in overnight or when the vehicle is parked for extended periods.

Always keep the power point caps closed when not being used.

Driver Controls

Cigar/Cigarette lighter (if equipped)

Do not plug optional electrical accessories into the cigarette lighter socket.

Do not hold the lighter in with your hand while it is heating, this will damage the lighter element and socket. The lighter will be released from its heating position when it is ready to be used.

Note: Improper use of the lighter can cause damage not covered by your warranty, and can result in fire or serious injury.

POWER WINDOWS



WARNING: Do not leave children unattended in the vehicle and do not let children play with the power windows. They may seriously injure themselves.



WARNING: When closing the power windows, you should verify they are free of obstructions and ensure that children and/or pets are not in the proximity of the window openings.

Press and pull the window switches to open and close windows.

- Push down (to the first detent) and hold the switch to open.
- Pull up (to the first detent) and hold the switch to close.

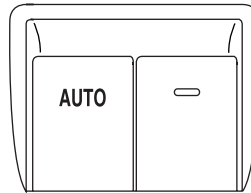

One touch down

Allows the driver's window to open fully without holding the control down. Press the switch completely down to the second detent and release quickly. The window will open fully. Momentarily press the switch to any position to stop the window operation.

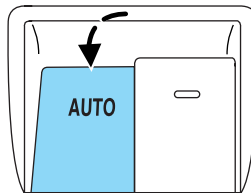

Driver Controls

Window lock

The window lock feature allows only the driver to operate the power windows.

To lock out all the window controls (except for the driver's) press the right side of the control. Press the left side to restore the window controls.

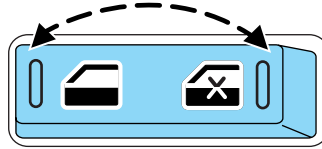

INTERIOR MIRROR

The interior rear view mirror has two pivot points on the support arm which lets you adjust the mirror up or down and from side to side.



WARNING: Do not adjust the mirror while the vehicle is in motion.

Automatic dimming interior rear view mirror (if equipped)

Your vehicle may be equipped with an interior rear view mirror which has an auto-dimming function. The electronic day/night mirror will change from the normal (high reflective) state to the non-glare (darkened) state when bright lights (glare) reach the mirror. When the mirror detects bright light from behind the vehicle, it will automatically adjust (darken) to minimize glare.

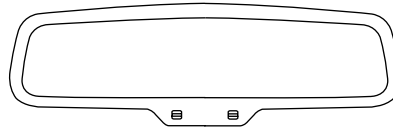

The mirror will automatically return to the normal state whenever the vehicle is placed in R (Reverse) to ensure a bright clear view when backing up.

Do not block the sensors on the front and back of the interior rear view mirror since this may impair proper mirror performance.

Do not clean the housing or glass of any mirror with harsh abrasives, fuel or other petroleum-based cleaning products.

Driver Controls

EXTERIOR MIRRORS

Power side view mirrors



WARNING: Do not adjust the mirror while the vehicle is in motion.

To adjust your mirrors:

1. Rotate the control clockwise to adjust the right mirror and rotate the control counterclockwise to adjust the left mirror.
2. Move the control in the direction you wish to tilt the mirror.
3. Return to the center position to lock mirrors in place.

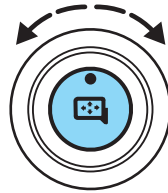

Heated outside mirrors (if equipped)

Both mirrors are heated automatically to remove ice, mist and fog when the rear window defrost is activated.

Do not remove ice from the mirrors with a scraper or attempt to readjust the mirror glass if it is frozen in place. These actions could cause damage to the glass and mirrors.

Do not clean the housing or glass of any mirror with harsh abrasives, fuel or other petroleum-based cleaning products.

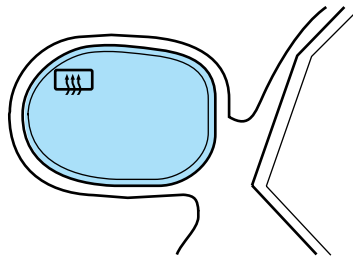

Fold-away mirrors

Fold the side mirrors in carefully when driving through a narrow space, like an automatic car wash.

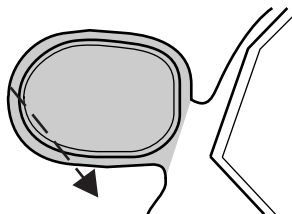

Driver Controls

POWER ADJUSTABLE FOOT PEDALS (IF EQUIPPED)

The accelerator and brake pedal should only be adjusted when the vehicle is stopped and the gearshift lever is in the P (Park) position.

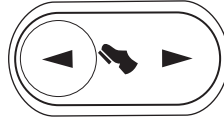

Press and hold the rocker control to adjust accelerator and brake pedal.

- Press the right side of the control to adjust the pedals toward you.
- Press the left side of the control to adjust the pedals away from you.

The adjustment allows for approximately 2.5 inches (65 mm) of maximum travel.



WARNING: Never adjust the accelerator and brake pedal with feet on the pedals while the vehicle is moving.

SPEED CONTROL (IF EQUIPPED)

With speed control set, you can maintain a set speed without keeping your foot on the accelerator pedal.



WARNING: Do not use the speed control in heavy traffic or on roads that are winding, slippery or unpaved.

Setting speed control

The controls for using your speed control are located on the steering wheel for your convenience.

1. Press the ON control and release it.
2. Accelerate to the desired speed.

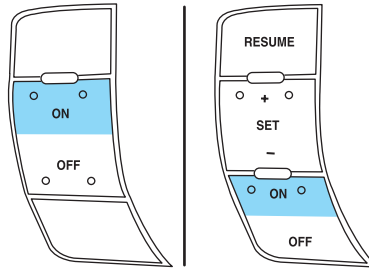

Driver Controls

3. Press the SET + control and release it.
4. Take your foot off the accelerator pedal.
5. The indicator  light (if equipped) on the instrument cluster will turn on.

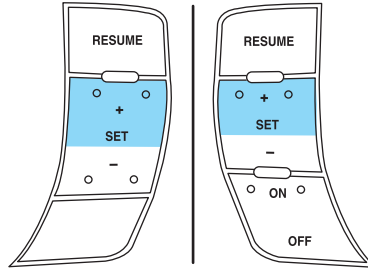

Note:

- Vehicle speed may vary momentarily when driving up and down a steep hill.
- If the vehicle speed increases above the set speed on a downhill, you may want to apply the brakes to reduce the speed.
- If the vehicle speed decreases more than 10 mph (16 km/h) below your set speed on an uphill, your speed control will disengage.

Disengaging speed control

To disengage the speed control:

- Depress the brake pedal

Disengaging the speed control will not erase previous set speed.

Resuming a set speed

Press the RESUME control and release it. This will automatically return the vehicle to the previously set speed.

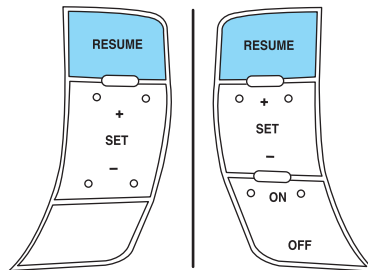

Driver Controls

Increasing speed while using speed control

There are two ways to set a higher speed:

- Press and hold the SET + control until you get to the desired speed, then release the control. You can also use the SET + control to operate the Tap-Up function. Press and release this control to increase the vehicle set speed in small amounts by 1 mph (1.6 km/h).
- Use the accelerator pedal to get to the desired speed. When the vehicle reaches that speed press and release the SET + control.

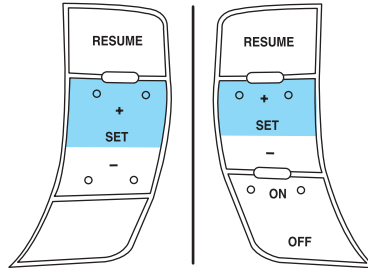

Reducing speed while using speed control

There are two ways to reduce a set speed:

- Press and hold the SET - control until you get to the desired speed, then release the control. You can also use the SET - control to operate the Tap-Down function. Press and release this control to decrease the vehicle set speed in small amounts by 1 mph (1.6 km/h).
- Depress the brake pedal until the desired vehicle speed is reached, press the SET + control.

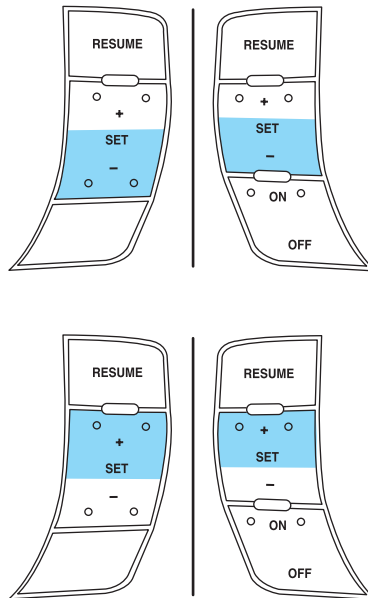

Driver Controls

Turning off speed control

There are two ways to turn off the speed control:

- Depress the brake pedal. This will not erase your vehicle's previously set speed.
- Press the speed control OFF control.

Note: When you turn the speed control or the ignition off, your speed control set speed memory is erased.

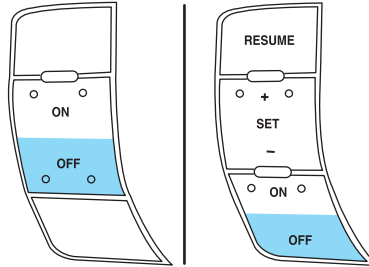

STEERING WHEEL CONTROLS (IF EQUIPPED)

Audio control features

In Radio mode:

- Press NEXT to select the next preset station within the current radio band.

In Tape mode:

- Press NEXT to listen to the next selection on the tape.

In CD mode:

- Press NEXT to listen to the next track on the disc.

In any mode:

- Press VOL + or - to adjust the volume.

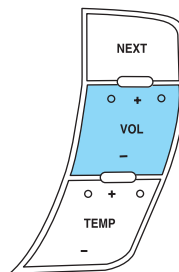
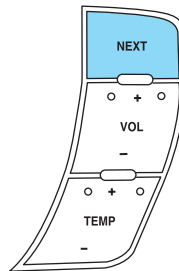

Driver Controls

Climate control features

- Press TEMP + or - to adjust temperature.

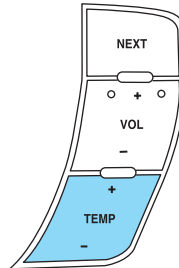

MESSAGE CENTER (IF EQUIPPED)

With the ignition in the on position, the message center, located on your instrument cluster, displays important vehicle information

through a constant monitor of vehicle systems. You may select display features on the message center for a display of status. The

system will also notify you of potential vehicle problems with a display of system warnings followed by a long indicator chime.

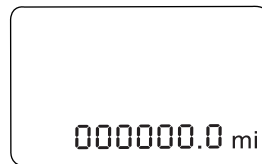
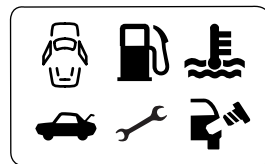
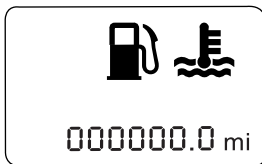
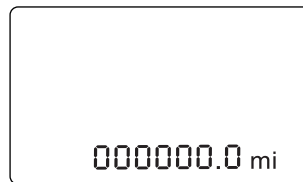

Your display can show up to three reconfigurable telltales at one time. What ever is displayed in the top left corner has the highest priority. Premium Display Severity Indicator (located under the message center): Indicates severity of the information being displayed on the premium display. Red for high severity, amber for medium severity, and non-lit for information only. For example, a door ajar warning would be accompanied by a red indicator, low fuel by an amber indicator, and fuel economy by an absence of the indicator. The indicator always illuminates with the highest severity rating of the warnings displayed.

Driver Controls

Selectable features

Select

Press this control to select functions shown in the INFO menu and SETUP menu.



Reset

Press this control to reset functions shown in the INFO menu and SETUP menu.



Info menu

This control displays the following control displays:

- Trip odometer/Odometer
- Distance to Empty
- Average Fuel Economy
- Instantaneous Fuel Economy
- Trip elapsed drive time

Odometer/Trip odometer

Refer to *Gauges* in the *Instrument Cluster* chapter.

Driver Controls

Distance to empty (DTE)

Selecting this function from the INFO menu estimates approximately how far you can drive with the fuel remaining in your tank under normal driving conditions.

Remember to turn the ignition off when refueling to allow this feature to correctly detect the added fuel.

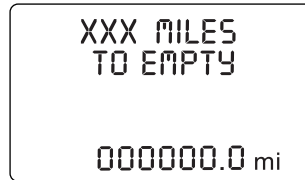

The DTE function will display FUEL LEVEL LOW and sound a tone for one second when you have approximately 50 miles (80 km) to empty. If you RESET this warning message, this display and tone will return within 10 minutes or 10 miles (16 km).

DTE is calculated using a running average fuel economy, which is based on your recent driving history of 500 miles (800 km). This value is not the same as the average fuel economy display. The running average fuel economy is reinitialized to a factory default value if the battery is disconnected.

Average fuel economy (AFE)

Select this function from the INFO menu to display your average fuel economy in miles/gallon or liters/100 km.

If you calculate your average fuel economy by dividing gallons of fuel used by 100 miles traveled (kilometers traveled by liters used), your figure may be different than displayed for the following reasons:

- Your vehicle was not perfectly level during fill-up
- Differences in the automatic shut-off points on the fuel pumps at service stations
- Variations in top-off procedure from one fill-up to another
- Rounding of the displayed values to the nearest 0.1 gallon (liter)

1. Drive the vehicle at least 5 miles (8 km) with the speed control system engaged to display a stabilized average.

2. Record the highway fuel economy for future reference.

It is important to press the RESET control (press and hold RESET for two seconds in order to reset the function) after setting the speed control to get accurate highway fuel economy readings.

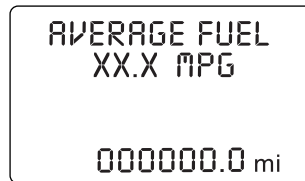

Driver Controls

Instantaneous fuel economy

Select this function from the INFO menu to display your instantaneous fuel economy. This will display your fuel economy as a bar graph ranging from ▼ poor economy to ▲ excellent economy.

Your vehicle must be moving to calculate instantaneous fuel economy. When your vehicle is not moving, this function shows ▼ one or no bars illuminated. Instantaneous fuel economy cannot be reset.

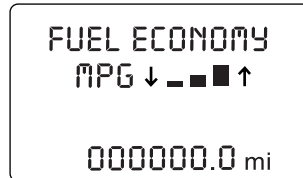

Trip elapsed drive time

Select this function from the INFO menu to display a timer.

To operate the Trip Elapsed Drive Time perform the following:

1. Press and release RESET in order to start the timer.
2. Press and release RESET to pause the timer.
3. Press and hold RESET for two seconds in order to reset the timer to zero.

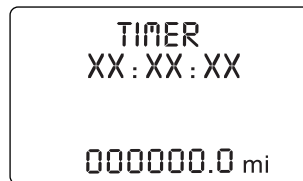

Setup menu

Press this control for the following displays:



- System Check
- Display (odometer/speedometer)
- Text Size (normal/large)
- Units (English/Metric)
- Language
- Oil Minder Start Value

Driver Controls

System check

Selecting this function from the SETUP menu causes the message center to cycle through each of the systems being monitored. For each of the monitored systems, the message center will indicate either an OK message or a warning message for three seconds.

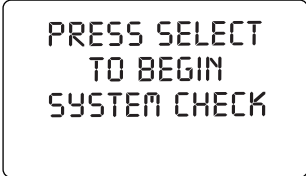

PRESS SELECT
TO BEGIN
SYSTEM CHECK

Pressing the SELECT control cycles the message center through each of the systems being monitored.

The sequence of the system check report and how it appears in the message center is as follows:

1. OIL LIFE
— PRESS RESET IF NEW OIL
2. WASHER FLUID
3. AIR SUSPENSION (if equipped)
4. RECONFIGURABLE TELLTALES
— OK
— FAILED RED
— FAILED AMBER

Display Type

1. Select this function from the SETUP menu.
2. Press the SELECT control to change the display.



SCREEN FORM
> ODOMETER
SPEEDO

Driver Controls

Text Size

1. Select this function from the SETUP menu.
2. Press the SELECT control to change text size.



TEXT SIZE
> NORMAL
LARGE

Units (English/Metric)

1. Select this function from the SETUP menu for the current units to be displayed.
2. Press the SELECT control to change from English to Metric.



UNITS
> ENGLISH
METRIC

Language

1. Select this function from the SETUP menu for the current language to be displayed.
2. Pressing the SELECT control cycles the message center through each of the language choices.



LANGUAGE
> ENGLISH
ESPAÑOL
FRANÇAIS

Oil Minder Start Value

1. Select this function from the SETUP control for the current display mode.

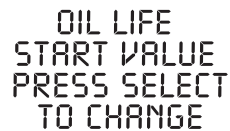

OIL LIFE
START VALUE
PRESS SELECT
TO CHANGE

Driver Controls

2. Press the SELECT control to change oil value.

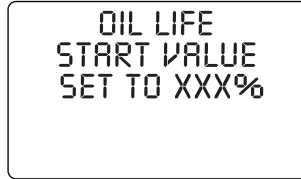

System warnings

System warnings alert you to possible problems or malfunctions in your vehicle's operating systems.

In the event of a multiple warning situation, the message center will cycle the display to show all warnings by displaying each one for four seconds.

The message center will display the last selected feature if there are no more warning messages. This allows you to use the full functionality of the message center after you acknowledge the warning by pressing the RESET control and clearing the warning message.

Warning messages that have been reset are divided into three categories:

- They cannot be reset until the condition is corrected.
- They will reappear on the display 10 minutes from the reset.
- They will not reappear until an ignition off-on cycle has been completed.

This acts as a reminder that these warning conditions still exist within the vehicle.

Warning display	Status
Door ajar	Warning cannot be reset
Coolant over temperature	Warning returns after 10 minutes
Powertrain malfunction	
Check fuel cap	
Check air suspension	
Fuel level low	

Driver Controls

Warning display	Status
Overdrive ON/OFF	Warning returns after the ignition key is turned from off to on.
Trunk ajar	
Low tire pressure	
Tire pressure monitor fault	
Tire pressure sensor fault	
Check compass module	
Low washer fluid	
Change engine oil	

DOOR AJAR — Displayed when a door is not completely closed.

POWERTRAIN MALFUNCTION — Displayed when the powertrain is not operating properly. If the warning stays on or continues to come on, contact your authorized dealer as soon as possible.

COOLANT OVER TEMPERATURE — Displayed when the engine coolant is overheating. Stop the vehicle as soon as safely possible, turn off the engine and let it cool. Check the coolant and coolant level. Refer to *Engine coolant* in the *Maintenance and Specifications* chapter. If the warning stays on or continues to come on, contact your authorized dealer as soon as possible.



WARNING: Never remove the coolant reservoir cap while the engine is running or hot.

CHECK FUEL CAP — Displayed when the fuel filler cap is not properly installed. Check the fuel filler cap for proper installation. Refer to *Fuel filler cap* in the *Maintenance and Specifications* chapter.

CHECK AIR SUSPENSION — Displayed when the air suspension system is not operating properly. If this message is displayed while driving, pull off the road as soon as safely possible. For more information, refer to *Air suspension system* in the *Driving* chapter.

FUEL LEVEL LOW — Displayed as an early reminder of a low fuel condition. Warning message can be reset by pressing the RESET button, but will return after 10 minutes. If any other button is pressed besides RESET, the message "PRESS RESET TO CLEAR" will appear in the message center. Once this message disappears (after approximately two seconds), press RESET to clear the warning.

TRUNK AJAR — Displayed when the trunk is not completely closed.

OVERDRIVE OFF — Displayed when the overdrive is enabled or disabled.

Driver Controls

LOW TIRE PRESSURE — Displayed when one or more tires on your vehicle have low tire pressure. Refer to *Inflating your tires* in the *Tires, Wheels and Loading* chapter.

TIRE PRESSURE MONITOR FAULT — Displayed when the Tire Pressure Monitoring System is malfunctioning. If the warning stays on or continues to come on, contact your authorized dealer as soon as possible.

TIRE PRESSURE SENSOR FAULT — Displayed when a tire pressure sensor is malfunctioning, or your spare tire is in use (Note: this includes the use of the optional full-sized matching spare tire and wheel). For more information on how the system operates under these conditions, refer to *Tire Pressure Monitoring System (TPMS)* in the *Tires, Wheels and Loading* chapter. If the warning stays on or continues to come on, contact your authorized dealer as soon as possible.

WASHER FLUID LEVEL LOW — Indicates the washer fluid reservoir is less than one quarter full. Check the washer fluid level. Refer to *Windshield washer fluid* in the *Maintenance and Specifications* chapter.

OIL LIFE CHANGE SOON — Displayed when the engine oil life remaining is 10% or less. When oil life left is between 10% and 0%, the XX% OIL LIFE CHANGE SOON message will be displayed.

OIL CHANGE REQUIRED — Displayed when the oil life left reaches 0%, the OIL CHANGE REQUIRED message will be displayed.

An oil change is required whenever indicated by the message center and according to the recommended maintenance schedule. USE ONLY RECOMMENDED ENGINE OILS.

To reset the oil monitoring system to 100% after each oil change (approximately 7,500 miles [12,000 km] or six months) perform the following:

1. Press and hold the RESET control for two seconds and release. Oil life is set to 100% and “OIL LIFE XXX% HOLD RESET IF NEW OIL” is displayed.

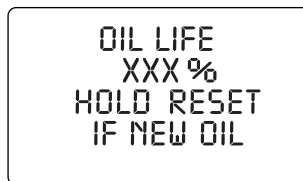

Driver Controls

2. Press and hold the RESET control for three seconds and release. Oil life is set to 100% and “OIL LIFE START VALUE SET TO XXX%” is displayed.

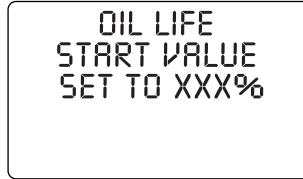

POSITIVE RETENTION FLOOR MAT

WARNING: Do not install additional floor mats on top of the factory installed floor mats as they may interfere with the accelerator or the brake pedals.

Position the driver floor mat so that the eyelet is over the pointed end of the retention post and rotate forward to lock in. Make sure that the mat does not interfere with the operation of the accelerator or the brake pedal. To remove the floor mat, reverse the installation procedure.

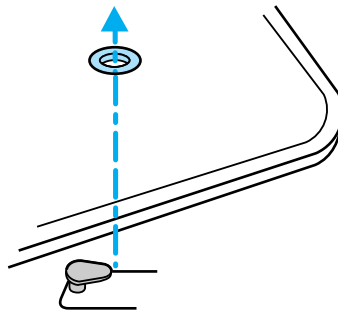

INTERIOR TRUNK CONTROL

The remote trunk release control is located on the driver's door trim panel and can be operated at any time.

You can render the switch inoperable by locking the button with your master key.

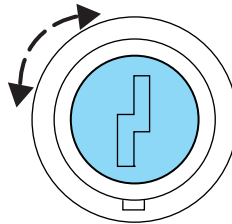



If equipped with a perimeter alarm system, the remote trunk release control and power door locks will be disabled when the vehicle perimeter alarm system is armed. This control will not work until the vehicle perimeter alarm system is disarmed. Refer to *Perimeter alarm system* in the *Locks and Security* chapter.

Locks and Security

KEYS

The vehicle is equipped with a master key which will access the vehicle's doors, trunk, glove box, ignition and remote trunk release.

POWER DOOR LOCKS

- Press the  control to unlock all doors.
- Press the  control to lock all doors.

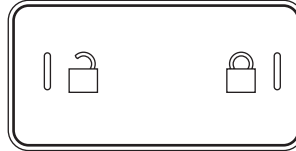

Smart locks (if equipped)

With the key in any ignition position, and either the driver's or passenger's door open, the doors cannot be locked using the power door lock switches.

The vehicle may still be locked with the key in the ignition, and performing one of the following actions:

- Pressing the manual lock button on the door.
- Operating the remote entry transmitter (if equipped).
- Operating the keyless entry keypad (if equipped).
- Operating the driver's door with a key.

Autolock (if equipped)

This feature automatically locks all vehicle doors when:

- all doors are closed,
- the engine is running,
- you shift into any gear, putting the vehicle in motion, and
- the vehicle's speed is greater than 3 mph (5 km/h).

Auto-relock

The autolock feature repeats when:

- a door is opened and closed while the engine is running,
- you shift into any gear, putting the vehicle in motion, and
- the vehicle's speed is greater than 3 mph (5 km/h).

Locks and Security

Auto-unlock

The auto-unlock feature will unlock all doors when:

- the ignition has been in the on position, all doors are closed, and the vehicle has been in motion at a speed greater than 12 mph (20 km/h),
- the vehicle has then come to a stop and the ignition is turned to the accessory or off position, and
- the driver door is opened (within ten minutes after the ignition was transitioned to the accessory or off position).

Note: The vehicle doors will not auto-unlock if the vehicle has been electronically locked prior to the driver door being opened.

Deactivating/activating the autolock or auto-unlock feature

Automatic door locks can also be turned on/off through the following procedure:

You must complete Steps 1-7 within 30 seconds or the procedure will have to be repeated. If the procedure needs to be repeated, you must wait at least 30 seconds. **Note:** Before following the procedure, make sure that the ignition is in the off position and all vehicle doors, the hood, and the decklid are closed.

1. Turn the ignition to the on position.
2. Press the power door unlock control on the door panel three times.
3. Turn the ignition from the on to the off position.
4. Press the power door unlock control three times.
5. Turn the ignition back to the on position.
6. The door locks will lock/unlock to confirm programming mode is entered/active.

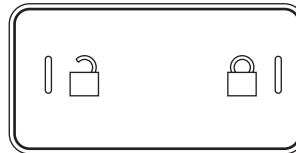

7. With the ignition still in the on position, **for the autolock feature**, press the unlock control once then press the lock control once. The horn will chirp once if autolock was deactivated or twice (one short and one long chirp) if autolock was activated. **For the auto-unlock feature**, press the lock control once, then press the unlock control once. The horn will chirp once if auto-unlock was deactivated or twice (one short and one long chirp) if auto-unlock was activated.

If any door, the hood, or the deck lid is open, the horn will chirp twice, and the procedure will need to be performed again.

Locks and Security

8. After having waited the necessary time for the programming to confirm, turn the ignition to the off position.

Once disabled, the autolock or auto-unlock feature can be enabled by repeating the procedure in Steps 1–8.

CHILDPROOF DOOR LOCKS

When these locks are set, the rear doors cannot be opened from the inside. The rear doors can be opened from the outside when the doors are unlocked.

The childproof locks are located on rear edge of each rear door and must be set separately for each door. Setting the lock for one door will not automatically set the lock for both doors.

Move lock control up to engage the childproof lock. Move control down to disengage childproof locks.

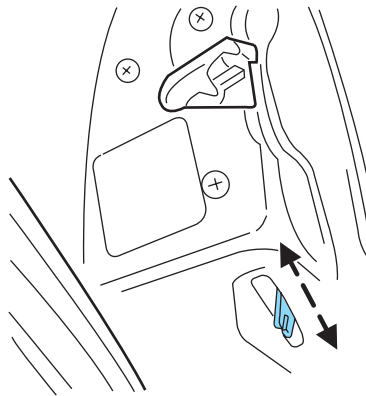

INTERIOR LUGGAGE COMPARTMENT RELEASE

Your vehicle is equipped with a mechanical interior luggage compartment release handle that provides a means of escape for children and adults in the event they become locked inside the luggage compartment.

Adults are advised to familiarize themselves with the operation and location of the release handle.

Locks and Security

To open the luggage compartment door (lid) from within the luggage compartment, pull the illuminated “T” shaped handle and push up on the trunk lid. The handle is composed of a material that will glow for hours in darkness following brief exposure to ambient light.

The “T” shaped handle will be located either on the luggage compartment door (lid) or inside the luggage compartment near the tail lamps.

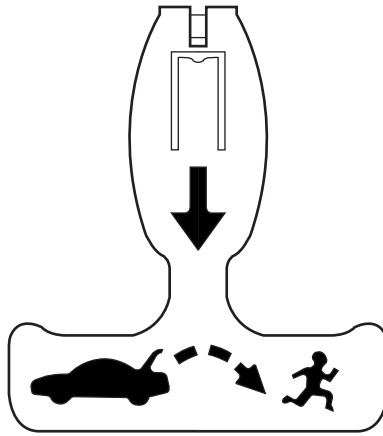

WARNING: Keep vehicle doors and luggage compartment locked and keep keys and remote transmitters out of a child's reach. Unsupervised children could lock themselves in the trunk and risk injury. Children should be taught not to play in vehicles.

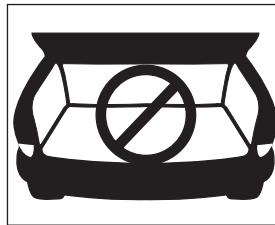

WARNING: Do not leave children, unreliable adults, or animals unattended in the vehicle. On hot days, the temperature in the trunk or vehicle interior can rise very quickly. Exposure of people or animals to these high temperatures for even a short time can cause death or serious heat-related injuries, including brain damage. Small children are particularly at risk.

Locks and Security

REMOTE ENTRY SYSTEM (IF EQUIPPED)

This device complies with part 15 of the FCC rules and with RSS-210 of Industry Canada. Operation is subject to the following two conditions: (1) This device may not cause harmful interference, and (2) This device must accept any interference received, including interference that may cause undesired operation.

Radio type approval numbers for remote entry receiver

If the type approval of your remote entry system is inspected in one of the countries listed in the following table, refer to the corresponding approval number:

Remote entry receiver certification numbers	
Gabon	01070305/ARTEL/GABTEL
Jordan	CAZ/ENG/CA/04/11/1
Zambia	TRC/LPD/2004/28

Changes or modifications not expressly approved by the party responsible for compliance could void the user's authority to operate the equipment.

The typical operating range for your remote entry transmitter is approximately 33 feet (10 meters). A decrease in operating range could be caused by:

- weather conditions,
- nearby radio towers,
- structures around the vehicle, or
- other vehicles parked next to your vehicle.



The remote entry system allows you to lock or unlock all vehicle doors without a key. **Note:** The remote entry features operate with the ignition in any position except in the on position, when the transmission is in any gear other than P (Park) or N (Neutral).

If there are problems with the remote entry system, make sure to take **ALL remote entry transmitters** with you to the authorized dealer in order to aid in troubleshooting the problem.





Locks and Security

Unlocking the doors

1. Press  and release to unlock the driver's door. **Note:** The interior lamps will illuminate.
2. Press  and release again within five seconds to unlock all the doors.

Locking the doors

Press  once to lock all the doors. Upon the first press the doors will lock and the parklamps/taillamps will flash once.

Press  again within three seconds to receive confirmation that the vehicle was successfully locked. **Note:** If all vehicle doors and the trunk are closed upon the second press of the , the horn will chirp once and the parklamps/taillamps will flash once to confirm the successful locking.

Upon the second press of the , if any door or the trunk is not securely closed the horn will chirp twice to warn that successfully locking was not complete. The park/taillamps will **not** flash if any door is ajar.

Car finder

Press  twice within three seconds. The horn will chirp and the parklamps/tail lamps will flash. It is recommended that this method be used to locate your vehicle, rather than using the panic alarm.

Sounding a panic alarm

Press  on the remote transmitter to activate the alarm.

Note: The panic alarm only works with the ignition in the off position.

Press  a second time to deactivate the alarm. You may also deactivate the alarm by turning the ignition to the on position.

Opening the trunk

Press  once to open the trunk.

- Ensure that the trunk is closed and latched before driving your vehicle. Failure to properly latch the trunk may cause objects to fall out or block the driver's rear view.

This feature will not work with a vehicle speed greater than 3 mph (5 km/h) if the ignition is in the accessory or on position.

Replacing the battery

The remote entry transmitter uses one coin type three-volt lithium battery CR2032 or equivalent.

Locks and Security

To replace the battery:

1. Twist a thin coin between the two halves of the remote entry transmitter near the key ring. **DO NOT TAKE THE RUBBER COVER AND CIRCUIT BOARD OFF THE FRONT HOUSING OF THE REMOTE ENTRY TRANSMITTER.**

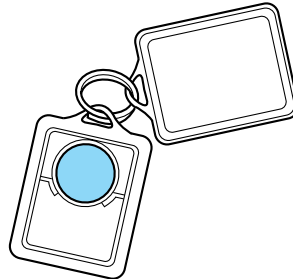

2. Do not wipe off any grease on the battery terminals on the back surface of the circuit board.

3. Remove the old battery.

Note: Please refer to local regulations when disposing of transmitter batteries.

4. Insert the new battery. Refer to the diagram inside the remote entry transmitter for the correct orientation of the battery. Press the battery down to ensure that the battery is fully seated in the battery housing cavity.

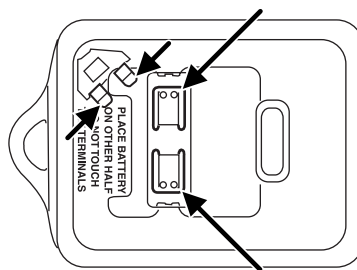

5. Snap the two halves back together.

Note: Replacement of the battery will **not** cause the remote transmitter to become deprogrammed from your vehicle. The remote transmitter should operate normally after battery replacement.

Replacing lost transmitters

Take all your vehicle's transmitters to your authorized dealer if service is required.

If a remote transmitter has been lost and you would like to remove it from the vehicle's memory, or you would like to purchase additional remote transmitters and have them programmed to your vehicle:

- Take **all** your vehicle's transmitters to your authorized dealer for programming, or
- Perform the following programming procedure yourself:

Locks and Security

Note: Ensure the brake pedal is not depressed during this sequence.

Place the key in the ignition and cycle from 1 (off) to 3 (on) eight times in rapid succession within 10 seconds. After doors lock/unlock, press any control on all transmitters (up to four). After pressing the control on each remote transmitter, the door will lock and unlock. If programming multiple remote transmitters, you must press the control buttons on each remote transmitter within seven seconds of each other to remain in programming mode. When completed, turn the ignition to 1 (off).

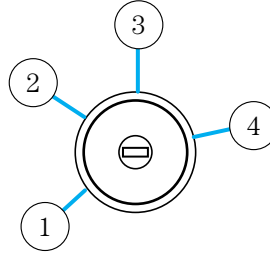

All transmitters **must** be programmed at the same time.

- When completed, turn the ignition to the 1 (on) position and wait at least 20 seconds in order to use the recently programmed transmitter(s).
- **All** transmitters **must** be programmed during the same programming cycle. A transmitter that is not programmed within the same programming cycle will be erased and will no longer operate your vehicle's locks. If this occurs, you will have to reprogram all the transmitters again, as you cannot just "add" a transmitter.

Illuminated entry

The interior lamps illuminate when the remote entry system is used to unlock the door(s) or sound the personal alarm.

The illuminated entry system will turn off the interior lights if:

- the ignition switch is turned to the on or the accessory positions, or
- the remote transmitter lock control is pressed, or
- after 25 seconds of illumination.

The dome lamp control must **not** be set to the **off** position for the illuminated entry system to operate.

The inside lights will not turn off if:

- they have been turned on with the dimmer control, or
- any door is open.

The battery saver will shut off the interior lamps 30 minutes after the last door is closed, or after 10 minutes if the last door is left open.

Locks and Security

SECURICODE™ KEYLESS ENTRY SYSTEM (IF EQUIPPED)

With the keyless entry keypad, you can:

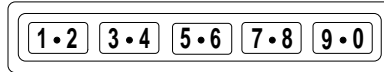

- lock or unlock the vehicle doors without using the key.
- open the trunk.

See also *Remote entry system* in this chapter for more information.

Your vehicle has a factory-set 5–digit code that operates the keyless entry system. You can also program your own 5–digit personal entry code.

The factory-set code is located:

- On the owner's wallet card in the glove compartment, or
- at your dealer.

When using the keyless entry keypad, press the middle of each button in order to ensure a good activation.

Programming a personal entry code

You can program up to three personal codes to unlock your vehicle. These codes do not replace the permanent code that the authorized dealer gave you.

To create your own personal entry code:

1. Enter the factory set code. **Note:** The keypad and the interior lamps will illuminate when pressed.
2. Within five seconds press 1 • 2 on the keypad to enter the programming mode.
3. Enter your personal 5–digit code. Each number must be entered within five seconds of each other.
4. Press 1 • 2 to store the first personal code.
5. The doors will lock then unlock to confirm programming of the new code.

To store a second personal code:

1. Enter the factory set code.
2. Within five seconds press 1 • 2 on the keypad to enter the programming mode.
3. Enter a second personal 5–digit code. Each number must be entered within five seconds of each other.

Locks and Security

4. Press 3 • 4 to store the second personal code.
5. The doors will again lock then unlock to confirm programming of the new code.

To store a third personal code:

1. Enter the factory set code.
2. Within five seconds press 1 • 2 on the keypad to enter the programming mode.
3. Enter a third personal 5-digit code. Each number must be entered within five seconds of each other.
4. Press 5 • 6 (or 7 • 8, or 9 • 0, or wait five seconds) to store the third personal code.
5. The doors will again lock then unlock to confirm programming of the new code.

Tips:

- Do not set a code that uses five of the same number.
- Do not use five numbers in sequential order.
- The factory set code will work even if you have set your own personal code.

Erasing personal code

To erase all of the personal entry codes programmed to a vehicle:

1. Enter the factory-set code.
2. Press and release 1 • 2 within five seconds of step 1.
3. Press and hold 1 • 2 for two seconds. All of the vehicle doors will lock and then unlock to confirm erasure.

Unlocking the doors and releasing the trunk with the keyless entry system

To unlock the driver door, enter either the factory-set code or personal code (each digit pressed within five seconds of prior digit). The interior lamps will illuminate.

- To **unlock all doors**, enter the factory-set code or personal code (driver door unlocks) and press 3 • 4 within five seconds.
- To **release the trunk**, enter the factory-set code or personal code (driver door unlocks) and press 5 • 6 within five seconds.

After the factory-set code or personal code has been entered, you can unlock all doors (press 3 • 4) and release the trunk (press 5 • 6) as long as the controls are pressed within five seconds of each other.

Locks and Security

Locking doors with the keyless entry system

It is not necessary to enter the factory-set code prior to locking all doors. To **lock the doors**, press 7 • 8 and press 9 • 0 at the same time.

Note: The doors will not lock if the driver door is ajar.

Anti-scan feature

If the wrong code has been entered seven times (35 consecutive button presses), the keypad will go into an anti-scan mode. This mode disables the keypad for one minute and the keypad lamp will flash.

The anti-scan feature will turn off after:

- one minute of keypad inactivity.
- pressing the  control on the remote entry transmitter.
- the ignition is turned to the on position.

SECURILOCK™ PASSIVE ANTI-THEFT SYSTEM

SecuriLock™ passive anti-theft system is an engine immobilization system. This system is designed to help prevent the engine from being started unless a **coded key programmed to your vehicle** is used. The use of the wrong type of coded key may lead to a “no-start” condition.

This device complies with part 15 of the FCC rules and with RSS-210 of Industry Canada. Operation is subject to the following two conditions: (1) This device may not cause harmful interference, and (2) This device must accept any interference received, including interference that may cause undesired operation.

Radio type approval numbers for Immobiliser System PATS XCVR

If the type approval of your immobilizer system is inspected in one of the countries listed in the following table, refer to the corresponding approval number:

Immobiliser System PATS XCVR certification numbers	
TX Frequency: 134,2 kHz	-8,1 dBµA/m @ 10 m
Country Name	Type Approval Number
American Samoa (USA)	See USA
Bahrain	DLM/GEN/18/18/16
Barbados	340/3 Vol.II
Canada	CANADA: 3043104475A
China	CMII ID:2005DJ0428

Locks and Security

Immobiliser System PATS XCVR certification numbers	
Ghana	SPLS / -485 / 2001
Guam (USA)	See USA
Jordan	4/U/U/4250
Kenya	CCK/ES/100/0
Kuwait	M.C/U.S.0 /5/7-12579
Mauritius	TA/2005/15
Mayotte (F)	CE 0682 0
Mexico	RLVVIVP03-324
Morocco	MR 1299 ANRT 2004
Netherlands Antilles (NL)	CE 0682 0
Nicaragua	NCG-CE-04-004
Northern Mariana Islands	See USA
Oman	OMA/1265(A) 1308/2001
Puerto Rico	See USA
Qatar	QTEL/SR/2003/R-276
Saudi Arabia	(10/1900)
South Korea	R-LPD1-04-0145
Tunisia	269/MAT/2004
United Arab Emirates	5/10-2/3274/3774
Uruguay	025/FR/2003
USA	NT8-15607PAT3XCVR
Zambia	CAZ/ENG/CA/2005/02/8

Changes or modifications not expressly approved by the party responsible for compliance could void the user's authority to operate the equipment.

Your vehicle comes with **two coded keys**; additional coded keys may be purchased from your authorized dealer. The authorized dealer can program your spare keys to your vehicle or you can program the keys yourself. Refer to *Programming spare keys* for instructions on how to program the coded key.

Note: The SecuriLock™ passive anti-theft system is not compatible with non-Ford aftermarket remote start systems. Use of these systems may result in vehicle starting problems and a loss of security protection.

Locks and Security

Note: Large metallic objects, electronic devices that are used to purchase gasoline or similar items, or a second coded key on the same key chain may cause vehicle starting issues. You need to prevent these objects from touching the coded key while starting the engine. These objects will not cause damage to the coded key, but may cause a momentary issue if they are too close to the key when starting the engine. If a problem occurs, turn the ignition to the off position, remove all objects on the key chain away from the coded key and restart the engine.

Note: Do not leave a duplicate coded key in the vehicle. Always take your keys and lock all doors when leaving the vehicle.

Anti-theft indicator

The anti-theft indicator is the flashing red indicator located on the dash panel.

- When the ignition is in the off position, the indicator will flash once every two seconds to indicate the SecuriLock™ system is functioning as a theft deterrent.
- When the ignition is in the on position, the indicator will glow for three seconds to indicate normal system functionality.

If a problem occurs with the SecuriLock™ system, the indicator will flash rapidly or glow steadily when the ignition is in the on position. If this occurs, contact your authorized dealer as soon as possible for service.

Automatic arming

The vehicle is armed immediately after switching the ignition to the off position.

The theft indicator on the instrument panel will flash every two seconds when the vehicle is armed.

Automatic disarming

Switching the ignition to the on position with a **coded key** disarms the vehicle.

- The theft indicator on the instrument panel will illuminate for three seconds and then go out.
- If the theft indicator stays on for an extended period of time or flashes rapidly, contact your authorized dealer as soon as possible.

Replacement keys

If your keys are lost or stolen and you don't have an extra coded key, you will need to have your vehicle towed to an authorized dealer. The key codes need to be erased from your vehicle and new coded keys will need to be programmed.

Locks and Security

Replacing coded keys can be very costly. Store an extra programmed key away from the vehicle in a safe place to help prevent any inconveniences. Please visit an authorized dealer to purchase additional spare or replacement keys.

Programming spare keys

A maximum of eight keys can be coded to your vehicle. Only SecuriLock™ keys can be used. To program a **coded key** yourself, you will need two previously programmed **coded keys** (keys that already operate your vehicle's engine) and the new unprogrammed key(s) readily accessible for timely implementation of each step in the procedure.

If two previously programmed coded keys are not available, you must bring your vehicle to your authorized dealer to have the spare coded key(s) programmed.

Please read and understand the entire procedure before you begin.

1. Insert the first previously programmed **coded key** into the ignition and turn the ignition from 1 (off) to the 3 (on) position (maintain ignition in 3 (on) for at least one second).

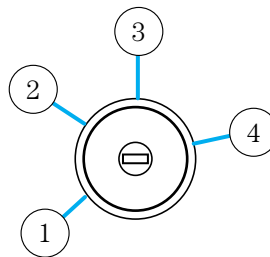

2. Turn ignition to 1 (off) and remove the first **coded key** from the ignition.

3. Within ten seconds of removing the first **coded key**, insert the second previously programmed **coded key** into the ignition and turn the ignition from 1 (off) to the 3 (on) position (maintain ignition in 3 (on) for at least one second but no more than ten seconds).

4. Turn the ignition to 1 (off) and remove the second **coded key** from the ignition.

5. Within twenty seconds of removing the second **coded key**, insert the new unprogrammed key (new key) into the ignition and turn the ignition from 1 (off) to the 3 (on) position (maintain ignition in 3 (on) for at least one second). This step will program your new key.

6. To program additional new unprogrammed key(s), wait at least 20 seconds and repeat this procedure from Step 1.

Locks and Security

If successful, the new coded key(s) will start the vehicle's engine and the theft indicator will illuminate for three seconds and then go out.

If not successful, the new coded key(s) will not start the vehicle's engine and the theft indicator will flash on and off. You may repeat Steps 1 through 6. If failure repeats, bring your vehicle to your authorized dealer to have the new spare key(s) programmed.

Seating and Safety Restraints

SEATING

Adjustable head restraints

 **WARNING:** To minimize the risk of neck injury in the event of a crash, the driver and passenger occupants should not sit in and/or operate the vehicle, until the head restraint is placed in its proper position. The driver should never adjust the head restraint while the vehicle is in motion.

Head restraints help to limit head motion in the event of a rear collision. To properly adjust your head restraints, lift the head restraint so that it is located directly behind your head or as close to that position as possible. Refer to the following to raise and lower the head restraints.

Raise the head restraint by pulling up on the head restraint.

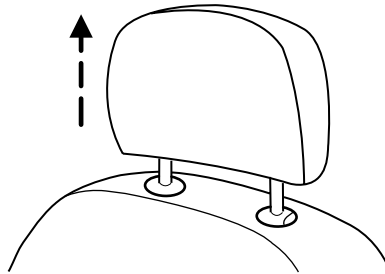

Push control to lower head restraint.

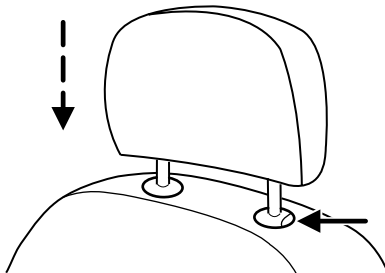

Adjusting the front manual seat (if equipped)

 **WARNING:** Never adjust the driver's seat or seatback when the vehicle is moving.

Seating and Safety Restraints



WARNING: Always drive and ride with your seatback upright and the lap belt snug and low across the hips.

Lift handle to move seat forward or backward.

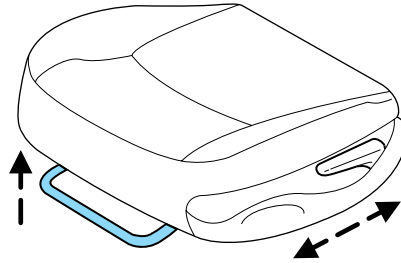

Pull lever up to adjust seatback.



WARNING: Before returning the seatback to its original position, make sure that cargo or any objects are not trapped behind the seatback. After returning the seatback to its original position, pull on the seatback to ensure that it has fully latched. An unlatched seat may become dangerous in the event of a sudden stop or collision.

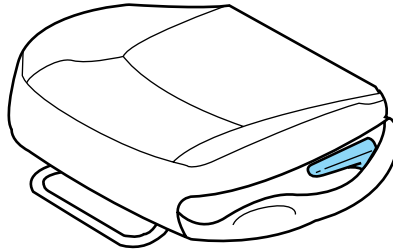

Using the manual recline function (if equipped)



WARNING: Never adjust the driver's seat or seatback when the vehicle is moving.



WARNING: Do not pile cargo higher than the seatbacks to avoid injuring people in a collision or sudden stop.



WARNING: Always drive and ride with your seatback upright and the lap belt snug and low across the hips.

Seating and Safety Restraints

 **WARNING:** Reclining the seatback can cause an occupant to slide under the seat's safety belt, resulting in severe personal injuries in the event of a collision.

To adjust the front seatback using the manual recliner:

- Lift and hold the handle located on the side of the seat.
- Lean against the seatback to adjust it to your desired position. You can recline the seat back or bring it forward.
- Release the handle when the desired position has been reached.

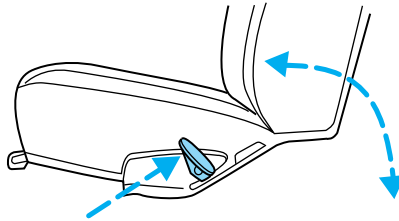



Adjusting the power front seats (if equipped)

The controls for the power seats are located on the inside of each front door.

 **WARNING:** Never adjust the driver's seat or seatback when the vehicle is moving.

 **WARNING:** Do not pile cargo higher than the seatbacks to avoid injuring people in a collision or sudden stop.

 **WARNING:** Always drive and ride with your seatback upright and the lap belt snug and low across the hips.

 **WARNING:** Reclining the seatback can cause an occupant to slide under the seat's safety belt, resulting in severe personal injuries in the event of a collision.

 **WARNING:** Sitting improperly out of position or with the seat back reclined too far can take off weight from the seat cushion and affect the decision of the passenger sensing system, resulting in serious injury or death in a crash. Always sit upright against your seatback, with your feet on the floor.

Seating and Safety Restraints

! **WARNING:** To reduce the risk of possible serious injury: Do not hang objects off seat back or stow objects in map pocket (if equipped) when a child is in the front passenger seat. Do not place objects underneath the front passenger seat or between the seat and the center console (if equipped). Check the “passenger airbag off” or “pass airbag off” indicator lamp for proper airbag status. Refer to *Front passenger sensing system* section for additional details. Failure to follow these instructions may interfere with the front passenger seat sensing system.

Press the control to recline the seatback forward or backward.

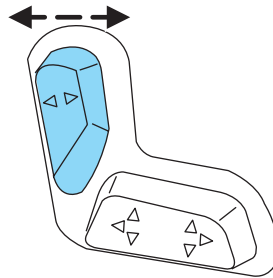

Press to move the seat forward or backward.

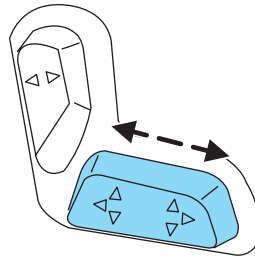

Seating and Safety Restraints

Press to move the front portion of the seat cushion up or down.

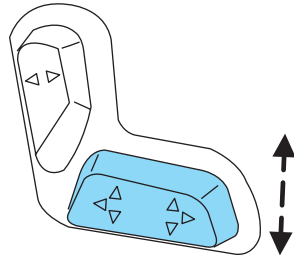

Press to move the rear portion of the seat cushion up or down.

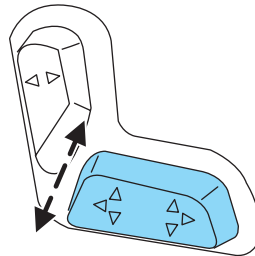

Using the power lumbar support (if equipped)

The power lumbar control is located on the outboard side of the seat.

Press one side of the control to adjust firmness.

Press the other side of the control to adjust softness.

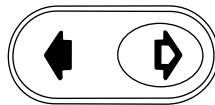

Seating and Safety Restraints

REAR SEATS

Seat-mounted cup holders and armrest storage compartment (if equipped)

To access the cup holders, fold the armrest down.

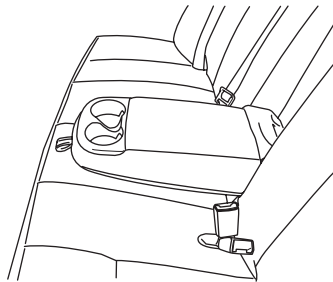

WARNING: Use only soft cups in the cup holder. Hard objects can injure you in a collision.

SAFETY RESTRAINTS

Personal Safety System®

The Personal Safety System® provides an improved overall level of frontal crash protection to front seat occupants and is designed to help further reduce the risk of airbag-related injuries. The system is able to analyze different occupant conditions and crash severity before activating the appropriate safety devices to help better protect a range of occupants in a variety of frontal crash situations.

Your vehicle's Personal Safety System® consists of the following items:

- Driver and passenger dual-stage airbag supplemental restraints
- Front safety belts with pretensioners, energy management retractors, and safety belt usage sensors
- Driver's seat position sensor
- Front crash severity sensor
- Front passenger sensing system
- "Passenger airbag off" or "pass airbag off" indicator lamp
- Restraints Control Module (RCM) with impact and safing sensors
- Restraint system warning light and back-up tone

Seating and Safety Restraints

- The electrical wiring for the airbags, crash sensor(s), safety belt pretensioners, front safety belt usage sensors, driver seat position sensor, front passenger sensing system, and indicator lights.

How does the Personal Safety System® work?

The Personal Safety System® can adapt the deployment strategy of your vehicle's safety devices according to crash severity and occupant conditions. A collection of crash and occupant sensors provides information to the Restraints control module (RCM). During a crash, the RCM may activate the safety belt pretensioners and/or either one or both stages of the dual-stage airbag supplemental restraints based on crash severity and occupant conditions.

The fact that the pretensioners or airbags did not activate for both front seat occupants in a collision does not mean that something is wrong with the system. Rather, it means the Personal Safety System® determined the accident conditions (crash severity, belt usage, etc.) were not appropriate to activate these safety devices. Front airbags are designed to activate only in frontal and near-frontal collisions, not rollovers, side-impacts, or rear-impacts unless the collision causes sufficient longitudinal deceleration.

Driver and passenger dual-stage airbag supplemental restraints

The dual-stage airbags offer the capability to tailor the level of airbag inflation energy. A lower, less forceful energy level is provided for more common, moderate-severity impacts. A higher energy level is used for the most severe impacts. Refer to *Airbag supplemental restraints (SRS)* section in this chapter.

Front crash severity sensor

The front crash severity sensor enhances the ability to detect the severity of an impact. Positioned up front, it provides valuable information early in the crash event on the severity of the impact. This allows your Personal Safety System® to distinguish between different levels of crash severity and modify the deployment strategy of the dual-stage airbags and safety belt pretensioners.

Driver's seat position sensor

The driver's seat position sensor allows your Personal Safety System® to tailor the deployment level of the driver dual-stage airbag based on seat position. The system is designed to help protect smaller drivers sitting close to the driver airbag by providing a lower airbag output level.

Seating and Safety Restraints

Front passenger sensing system

For airbags to do their job they must inflate with great force, and this force can pose a potentially deadly risk to occupants that are very close to the airbag when it begins to inflate. For some occupants, like infants in rear-facing child seats, this occurs because they are initially sitting very close to the airbag. For other occupants, this occurs when the occupant is not properly restrained by safety belts or child safety seats and they move forward during pre-crash braking. The most effective way to reduce the risk of unnecessary injuries is to make sure all occupants are properly restrained. Accident statistics suggest that children are much safer when properly restrained in the rear seating positions than in the front.



WARNING: Air bags can kill or injure a child in a child seat. **NEVER** place a rear-facing child seat in front of an active air bag. If you must use a forward-facing child seat in the front seat, move the seat all the way back.



WARNING: When possible, all children 12 years old and under should be properly restrained in a rear seating position.

The front passenger sensing system can automatically turn off the front passenger airbag and passenger seat-mounted side airbag. The system is designed to help protect small (child size) occupants from frontal airbag deployments when they are seated or restrained in the front passenger seat contrary to proper child-seating or restraint usage recommendations. Even with this technology, parents are **STRONGLY** encouraged to always properly restrain children in the rear seat. The sensor also turns off the passenger front airbag when the passenger seat is empty. The sensor turns off the passenger seat-mounted side airbag when the seat is empty and the safety belt is unbuckled.

When the front passenger seat is occupied and the sensing system has turned off the passenger's frontal airbag, the "pass airbag off" indicator will light and stay lit to remind you that the front passenger frontal airbag is off. See *Front passenger sensing system* in the airbags section of this chapter.

Front safety belt usage sensors

The front safety belt usage sensors detect whether or not the driver and front outboard passenger safety belts are fastened. This information allows your Personal Safety System® to tailor the airbag deployment and safety belt pretensioner activation depending upon safety belt usage.

Seating and Safety Restraints

Front safety belt pretensioners

The safety belt pretensioners at the front outboard seating positions are designed to tighten the safety belts firmly against the occupant's body during frontal collisions and in side collisions. This helps increase the effectiveness of the safety belts. In frontal collisions, the safety belt pretensioners can be activated alone or, if the collision is of sufficient severity, together with the front airbags.

Front safety belt energy management retractors

The front outboard safety belt energy management retractors allow webbing to be pulled out of the retractor in a gradual and controlled manner in response to the occupant's forward momentum. This helps reduce the risk of force-related injuries to the occupant's chest by limiting the load on the occupant. Refer to *Energy management feature* section in this chapter.

Determining if the Personal Safety System® is operational

The Personal Safety System® uses a warning light in the instrument cluster or a back-up tone to indicate the condition of the system. Refer to the *Warning light and chimes* section in the *Instrument cluster* chapter. Routine maintenance of the Personal Safety System® is not required.

The Restraints control module (RCM) monitors its own internal circuits and the circuits for the airbag supplemental restraints, crash sensor(s), safety belt pretensioners, front safety belt buckle sensors, front passenger sensing system, and the driver seat position sensor. In addition, the RCM also monitors the restraints warning light in the instrument cluster. A difficulty with the system is indicated by one or more of the following.

- The warning light will either flash or stay lit.
- The warning light will not illuminate immediately after ignition is turned on.
- A series of five beeps will be heard. The tone pattern will repeat periodically until the problem and warning light are repaired.

If any of these things happen, even intermittently, have the Personal Safety System® serviced at an authorized dealer immediately. Unless serviced, the system may not function properly in the event of a collision.

Seating and Safety Restraints

Safety restraints precautions



WARNING: Always drive and ride with your seatback upright and the lap belt snug and low across the hips.



WARNING: To reduce the risk of injury, make sure children sit in a rear seating position where they can be properly restrained.



WARNING: Never let a passenger hold a child on his or her lap while the vehicle is moving. The passenger cannot protect the child from injury in a collision.



WARNING: All occupants of the vehicle, including the driver, should always properly wear their safety belts, even when an airbag supplemental restraint system (SRS) is provided.



WARNING: It is extremely dangerous to ride in a cargo area, inside or outside of a vehicle. In a collision, people riding in these areas are more likely to be seriously injured or killed. Do not allow people to ride in any area of your vehicle that is not equipped with seats and safety belts. Be sure everyone in your vehicle is in a seat and using a safety belt properly.



WARNING: In a rollover crash, an unbelted person is significantly more likely to die than a person wearing a safety belt.





WARNING: Each seating position in your vehicle has a specific safety belt assembly which is made up of one buckle and one tongue that are designed to be used as a pair. 1) Use the shoulder belt on the outside shoulder only. Never wear the shoulder belt under the arm. 2) Never swing the safety belt around your neck over the inside shoulder. 3) Never use a single belt for more than one person.



WARNING: When possible, all children 12 years old and under should be properly restrained in a rear seating position.

Seating and Safety Restraints

 **WARNING:** Safety belts and seats can become hot in a vehicle that has been closed up in sunny weather; they could burn a small child. Check seat covers and buckles before you place a child anywhere near them.

 **WARNING:** Front and rear seat occupants, including pregnant women, should wear safety belts for optimum protection in an accident.

Combination lap and shoulder belts

1. Insert the belt tongue into the proper buckle (the buckle closest to the direction the tongue is coming from) until you hear a snap and feel it latch. Make sure the tongue is securely fastened in the buckle.

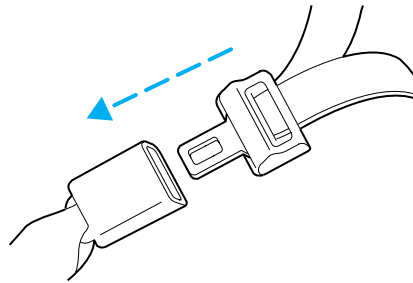

2. To unfasten, push the release button and remove the tongue from the buckle.

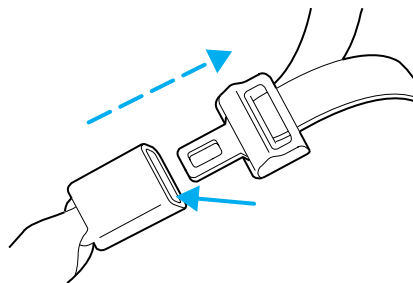

Energy management feature

- This vehicle has a safety belt system with an energy management feature at the front outboard seating positions to help further reduce the risk of injury in the event of a head-on collision.
- The energy management feature is designed to pay out webbing in a controlled manner. This feature is designed to help reduce the belt force acting on the occupant's chest.

Seating and Safety Restraints

Lap belts

Adjusting the front center seat lap belt (if equipped)



WARNING: The lap belt should fit snugly and as low as possible around the hips, not across the waist.

The lap belt does not adjust automatically. Insert the tongue into the correct buckle (the buckle closest to the direction the tongue is coming from). To lengthen the belt, turn the tongue at a right angle to the belt and pull across your lap until it reaches the buckle. To tighten the belt, pull the loose end of the belt through the tongue until it fits snugly across the hips.

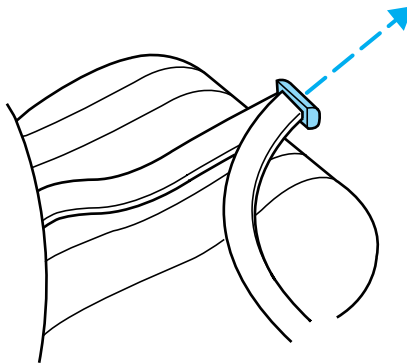

Shorten and fasten the belt when not in use.

The front outboard and rear safety restraints in the vehicle are combination lap and shoulder belts. The front outboard passenger and rear seat safety belts have three types of locking modes described as follows:

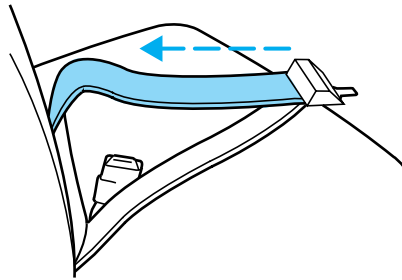

Vehicle sensitive mode

This is the normal retractor mode, which allows free shoulder belt length adjustment to your movements and locking in response to vehicle movement. For example, if the driver brakes suddenly or turns a corner sharply, or the vehicle receives an impact of approximately 5 mph (8 km/h) or more, the combination safety belts will lock to help reduce forward movement of the driver and passengers.

Seating and Safety Restraints

Webbing extraction sensitive mode

The webbing sensitive locking mode locks the webbing and prevents more belt from being pulled out if the belt is pulled out too quickly. The belt will unlock when you stop pulling on it.

Automatic locking mode

In this mode, the shoulder belt is pre-locked. The belt will still retract to remove any slack in the shoulder belt.

The automatic locking mode is not available on the driver safety belt.

When to use the automatic locking mode

- **Any time** a child safety seat, except a booster, is installed in a passenger front outboard or any rear seating position. Children 12 years old and under should be properly restrained in the rear seat whenever possible. Refer to *Safety restraints for children* or *Safety seats for children* later in this chapter.

How to use the automatic locking mode

- Buckle the combination lap and shoulder belt.

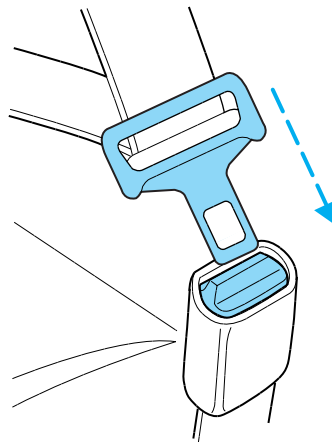

Seating and Safety Restraints

- Grasp the shoulder portion and pull downward until the entire belt is pulled out.



- Allow the belt to retract. As the belt retracts, you will hear a clicking sound. This indicates the safety belt is now in the automatic locking mode.

How to disengage the automatic locking mode

! **WARNING:** Ford Motor Company recommends that all passenger safety belt assemblies and attaching hardware should be inspected by an authorized dealer after any collision to verify that the "automatic locking retractor" feature for child seats is still working properly. Safety belt assemblies should be inspected by an authorized dealer and must be replaced if either damage or improper operation is noted. Failure to replace the belt and retractor assembly could increase the risk of injury in a collision.

Unbuckle the combination lap/shoulder belt and allow it to retract completely to disengage the automatic locking mode and activate the vehicle sensitive (emergency) locking mode.

Safety belt extension assembly

If the safety belt is too short when fully extended, there is an 8 inch (20 cm) safety belt extension assembly that can be added (part number 611C22). This assembly can be obtained from an authorized dealer.

Use only extensions manufactured by the same supplier as the safety belt. Manufacturer identification is located at the end of the webbing on the label. Also, use the safety belt extension only if the safety belt is too short for you when fully extended.

! **WARNING:** Do not use extensions to change the fit of the shoulder belt across the torso.

Seating and Safety Restraints

Front safety belt height adjustment

Your vehicle has safety belt height adjustments for the driver and front outboard passenger. Adjust the height of the shoulder belt so the belt rests across the middle of your shoulder.

To lower the shoulder belt height, push the button and slide the height adjuster down. To raise the height of the shoulder belt, push the button and slide the height adjuster

up. Pull down on the height adjuster to make sure it is locked in place.

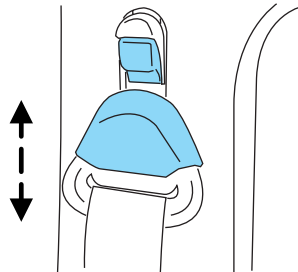

WARNING: Position the safety belt height adjusters so that the belt rests across the middle of your shoulder. Failure to adjust the safety belt properly could reduce the effectiveness of the seat belt and increase the risk of injury in a collision.

Safety belt warning light and indicator chime

The safety belt warning light illuminates in the instrument cluster and a chime sounds to remind the occupants to fasten their safety belts.

Conditions of operation

If...	Then...
The driver's safety belt is not buckled before the ignition switch is turned to the on position...	The safety belt warning light illuminates 1-2 minutes and the warning chime sounds 4-8 seconds.
The driver's safety belt is buckled while the indicator light is illuminated and the warning chime is sounding...	The safety belt warning light and warning chime turn off.
The driver's safety belt is buckled before the ignition switch is turned to the on position...	The safety belt warning light and indicator chime remain off.

Seating and Safety Restraints

Belt-Minder®

The Belt-Minder® feature is a supplemental warning to the safety belt warning function. This feature provides additional reminders by intermittently sounding a chime and illuminating the safety belt warning light in the instrument cluster when the driver's and front passenger's safety belt is unbuckled.

The Belt-Minder® feature uses information from the front passenger sensing system to determine if a front seat passenger is present and therefore potentially in need of a warning. To avoid activating the Belt-Minder® feature for objects placed in the front passenger seat, warnings will only be given to large front seat occupants as determined by the front passenger sensing system.

Both the driver's and passenger's safety belt usages are monitored and either may activate the Belt-Minder® feature. The warnings are the same for the driver and the front passenger. If the Belt-Minder® warnings have expired (warnings for approximately five minutes) for one occupant (driver or front passenger), the other occupant can still activate the Belt-Minder® feature.

If...	Then...
The driver's and front passenger's safety belts are buckled before the ignition switch is turned to the on position or less than 1-2 minutes have elapsed since the ignition switch has been turned to on...	The Belt-Minder® feature will not activate.
The driver's or front passenger's safety belt is not buckled when the vehicle has reached at least 3 mph (5 km/h) and 1-2 minutes have elapsed since the ignition switch has been turned to on...	The Belt-Minder® feature is activated - the safety belt warning light illuminates and the warning chime sounds for six seconds every 30 seconds, repeating for approximately five minutes or until the safety belts are buckled.

Seating and Safety Restraints

If...	Then...
The driver's or front passenger's safety belt becomes unbuckled for approximately one minute while the vehicle is traveling at least 3 mph (5 km/h) and more than 1-2 minutes have elapsed since the ignition switch has been turned to on...	The Belt-Minder® feature is activated - the safety belt warning light illuminates and the warning chime sounds for six seconds every 30 seconds, repeating for approximately five minutes or until the safety belts are buckled.

The following are reasons most often given for not wearing safety belts (All statistics based on U.S. data):

Reasons given...	Consider...
"Crashes are rare events"	36700 crashes occur every day. The more we drive, the more we are exposed to "rare" events, even for good drivers. <i>1 in 4 of us will be seriously injured in a crash during our lifetime.</i>
"I'm not going far"	3 of 4 fatal crashes occur within 25 miles (40 km) of home.
"Belts are uncomfortable"	We design our safety belts to enhance comfort. If you are uncomfortable - try different positions for the safety belt upper anchorage and seatback which should be as upright as possible; this can improve comfort.
"I was in a hurry"	Prime time for an accident. Belt-Minder® reminds us to take a few seconds to buckle up.
"Safety belts don't work"	Safety belts , when used properly, reduce risk of death to front seat occupants by 45% in cars , and by 60% in light trucks .

Seating and Safety Restraints

Reasons given...	Consider...
“Traffic is light”	Nearly 1 of 2 deaths occur in single-vehicle crashes , many when no other vehicles are around.
“Belts wrinkle my clothes”	Possibly, but a serious crash can do much more than wrinkle your clothes, particularly if you are unbelted.
“The people I’m with don’t wear belts”	Set the example, teen deaths occur 4 times more often in vehicles with TWO or MORE people. Children and younger brothers/sisters imitate behavior they see.
“I have an airbag”	Airbags offer greater protection when used with safety belts. Frontal airbags are not designed to inflate in rear and side crashes or rollovers.
“I’d rather be thrown clear”	Not a good idea. People who are ejected are 40 times more likely to DIE . Safety belts help prevent ejection, WE CAN’T “PICK OUR CRASH”.



WARNING: Do not sit on top of a buckled safety belt or insert a latchplate into the buckle to avoid the Belt-Minder® chime. To do so may adversely affect the performance of the vehicle’s air bag system.

One-time disable

If at any time the driver/front passenger quickly buckles then unbuckles the safety belt for that seating position, the Belt-Minder® is disabled for the current ignition cycle. The Belt-Minder® feature will enable during the same ignition cycle if the occupant buckles and remains buckled for approximately 30 seconds. Confirmation is not given for the one time disable.

Deactivating/activating the Belt-Minder® feature

The driver and front passenger Belt-Minder® are deactivated/activated independently. When deactivating/activating one seating position, do not buckle the other position as this will terminate the process.

Seating and Safety Restraints

Read Steps 1 - 4 thoroughly before proceeding with the deactivation/activation programming procedure.

Note: The driver and front passenger Belt-Minder® features must be disabled/enabled separately. Both cannot be disabled/enabled during the same key cycle.

The driver and front passenger Belt-Minder® features can be deactivated/activated by performing the following procedure:

Before following the procedure, make sure that:

- The parking brake is set.
- The gearshift is in P (Park).
- The ignition switch is in the off position.
- The driver and front passenger safety belts are unbuckled.



WARNING: While the design allows you to deactivate your Belt-Minder®, this system is designed to improve your chances of being safely belted and surviving an accident. We recommend you leave the Belt-Minder® system activated for yourself and others who may use the vehicle. To reduce the risk of injury, do not deactivate/activate the Belt-Minder® feature while driving the vehicle.

1. Turn the ignition switch to the on position. **DO NOT START THE ENGINE.**
2. Wait until the safety belt warning light turns off (Approximately one minute).
 - Step 3 must be completed within 50 seconds after the safety belt warning light turns off.
3. For the seating position being disabled, at a moderate speed, buckle then unbuckle the safety belt nine times, ending in the unbuckled state. Step 3 must be completed within 50 seconds after the safety belt warning light turns off.
 - After Step 3, the restraint system warning light (airbag light) will be turned on for three seconds.
4. Within approximately seven seconds of the light turning off, buckle then unbuckle the safety belt.
 - This will disable the Belt-Minder® feature for that seating position if it is currently enabled. As confirmation, the restraint system warning light will flash four times per second for three seconds.

Seating and Safety Restraints

- This will enable the Belt-Minder® feature for that seating position if it is currently disabled. As confirmation, the restraint system warning light will flash four times per second for three seconds, followed by three seconds with the light off, then followed by the restraint system warning light flashing four times per second for three seconds again.

AIRBAG SUPPLEMENTAL RESTRAINT SYSTEM (SRS)

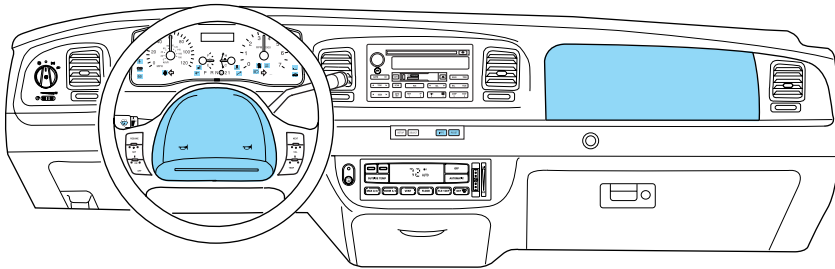

Important SRS precautions

The SRS is designed to work with the safety belt to help protect the driver and right front passenger from certain upper body injuries. Airbags DO NOT inflate slowly; there is a risk of injury from a deploying airbag.

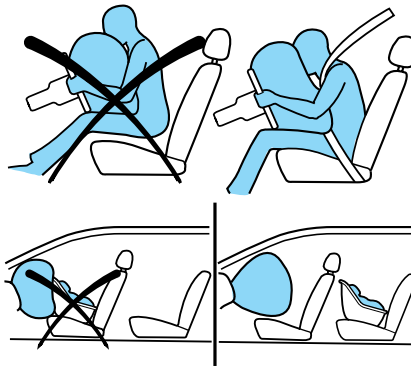

WARNING: All occupants of the vehicle, including the driver, should always properly wear their safety belts, even when an air bag supplemental restraint system (SRS) is provided.

WARNING: When possible, all children 12 years old and under should be properly restrained in a rear seating position.

Seating and Safety Restraints



WARNING: The National Highway Traffic Safety Administration (NHTSA) recommends a minimum distance of at least 10 inches (25 cm) between an occupant's chest and the driver airbag module.



WARNING: Never place your arm over the air bag module as a deploying air bag can result in serious arm fractures or other injuries.



WARNING: Ford Motor Company recommends that an authorized dealer inspect all steering column assemblies in use in vehicles involved in a collision. Failure to inspect and if necessary replace the steering column assembly could result in severe injury or death in the event of a collision.



WARNING: Do not attempt to service, repair, or modify the steering column, its adaptive module, or its fuses. See your authorized dealer.

To properly position yourself away from the airbag:

- Move your seat to the rear as far as you can while still reaching the pedals comfortably.
- Recline the seat slightly one or two degrees from the upright position.



WARNING: Do not put anything on or over the air bag module. Placing objects on or over the air bag inflation area may cause those objects to be propelled by the air bag into your face and torso causing serious injury.



WARNING: Do not attempt to service, repair, or modify the airbag supplemental restraint systems or its fuses. See your authorized dealer.



WARNING: The front passenger airbag is not designed to offer protection to an occupant in the center front seating position.

Seating and Safety Restraints

 **WARNING:** Modifying or adding equipment to the front end of the vehicle (including frame, bumper, front end body structure and tow hooks) may affect the performance of the airbag system, increasing the risk of injury. Do not modify the front end of the vehicle.

Children and airbags

Children must always be properly restrained. Accident statistics suggest that children are safer when properly restrained in the rear seating positions than in the front seating position. Failure to follow these instructions may increase the risk of injury in a collision.

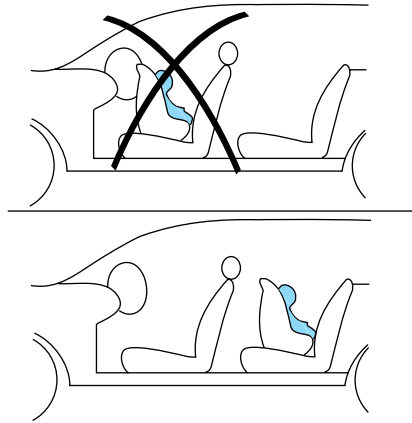

 **WARNING:** Airbags can kill or injure a child in a child seat. **NEVER** place a rear-facing child seat in front of an active airbag. If you must use a forward-facing child seat in the front seat, move the seat all the way back.

Seating and Safety Restraints

⚠ WARNING: Front seating positions only: If seating two adults and a child, Ford recommends properly restraining the child in the center front seating position, but only if doing so will not interfere with driving the vehicle. This arrangement provides lap and shoulder belt and airbag protection for adult occupants and an attachment method for a child restraint. If the child seat interferes with driving the vehicle and the child restraint is forward-facing, the child may be restrained in the passenger seat. Move the seat as far rearward as possible to minimize the likelihood of interaction with the front passenger airbag. Never place a rear-facing child seat in front of an active airbag. All occupants of the vehicle should always properly wear their safety belts. Ensure the child is properly restrained in an appropriate child seat or with the use of a booster.

How does the airbag supplemental restraint system work?

The airbag SRS is designed to activate when the vehicle sustains longitudinal deceleration sufficient to cause the sensors to close an electrical circuit that initiates airbag inflation.

The fact that the airbags did not inflate in a collision does not mean that something is wrong with the system. Rather, it means the forces were not of the type sufficient to cause activation. Driver and passenger airbags are designed to inflate in frontal and near-frontal collisions, not rollover, side-impact, or rear-impacts unless the collision causes sufficient longitudinal deceleration.

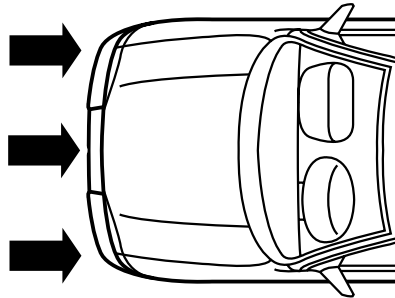

Seating and Safety Restraints

The airbags inflate and deflate rapidly upon activation. After airbag deployment, it is normal to notice a smoke-like, powdery residue or smell the burnt propellant. This may consist of cornstarch, talcum powder (to lubricate the bag) or sodium compounds (e.g., baking soda) that result from the combustion process that inflates the airbag. Small amounts of sodium hydroxide may be present which may irritate the skin and eyes, but none of the residue is toxic.



While the system is designed to help reduce serious injuries, contact with a deploying airbag may also cause abrasions, swelling or temporary hearing loss. Because airbags must inflate rapidly and with considerable force, there is the risk of death or serious injuries such as fractures, facial and eye injuries or internal injuries, particularly to occupants who are not properly restrained or are otherwise out of position at the time of airbag deployment. Thus, it is extremely important that occupants be properly restrained as far away from the airbag module as possible while maintaining vehicle control.

The SRS consists of the following items:

- Driver and passenger airbag modules (which include the inflators and airbags)
- safety belt pretensioners
- Front passenger sensing system
- “Passenger airbag off” or “pass airbag off” indicator lamp. Refer to *Front passenger sensing system* later in this chapter.
- Driver and passenger side airbags
- One or more impact and safing sensors
- A readiness light and tone
- A diagnostic module
- The electrical wiring which connects the components

The diagnostic module monitors its own internal circuits as well as the supplemental airbag electrical system wiring (including the impact sensors), the system wiring, the airbag system readiness light, the airbag back up power and the airbag ignitors.

Seating and Safety Restraints



WARNING: Several air bag system components get hot after inflation. Do not touch them after inflation.



WARNING: If the air bag has deployed, **the air bag will not function again and must be replaced immediately.** If the air bag is not replaced, the unrepaired area will increase the risk of injury in a collision.



WARNING: If the safety belt pretensioners deploy in an accident, they will not function again (belt will not extract or retract) and must be replaced immediately. Failure to replace the retractor assemblies will increase the risk of injury.

Front passenger sensing system

The front passenger sensing system is designed to meet the regulatory requirements of Federal Motor Vehicle Safety Standard (FMVSS) 208 and is designed to disable (will not inflate) the front passenger's frontal airbag under certain conditions.

The front passenger sensing system works with sensors that are part of the front passenger's seat and safety belt. The sensors are designed to detect the presence of a properly seated occupant and determine if the front passenger's frontal airbag should be enabled (may inflate) or disabled (will not inflate).

The front passenger sensing system will disable (will not inflate) the front passenger's frontal airbag if:

- the front passenger seat is unoccupied, or has small/medium objects in the front seat,
- the system determines that an infant is present in a rear-facing infant seat that is installed according to the manufacturer's instructions,
- the system determines that a small child is present in a forward-facing child restraint that is installed according to the manufacturer's instructions,
- the system determines that a small child is present in a booster seat,
- a front passenger takes his/her weight off of the seat for a period of time,

Seating and Safety Restraints

For side airbag equipped vehicles, the front passenger sensing system will turn off the passenger seat side airbag if:

- the seat is empty and safety belt is unbuckled.

The front passenger sensing system uses a "passenger airbag off" or "pass airbag off" indicator which will illuminate and stay lit to remind you that the front passenger frontal airbag is disabled. The indicator lamp is located on the instrument panel to the right of the radio over the glove box.



Note: The indicator lamp will illuminate for a short period of time when the ignition is turned to the on position to confirm it is functional.

When the front passenger seat is not occupied (empty seat) or in the event that the front passenger frontal airbag is enabled (may inflate), the indicator lamp will be unlit.

The front passenger sensing system is designed to disable (will not inflate) the front passenger's frontal airbag when a rear facing infant seat, a forward-facing child restraint, or a booster seat is detected.

- When the front passenger sensing system disables (will not inflate) the front passenger frontal airbag, the indicator lamp will illuminate and stay lit to remind you that the front passenger frontal airbag is disabled.
- If the child restraint has been installed and the indicator lamp is not lit, then turn the vehicle off, remove the child restraint from the vehicle and reinstall the restraint following the child restraint manufacturer's instructions.

The front passenger sensing system is designed to enable (may inflate) the front passenger's frontal airbag anytime the system senses that a person of adult size is sitting properly in the front passenger seat.

- When the front passenger sensing system enables the front passenger frontal airbag (may inflate), the indicator will be unlit and stay unlit.

If a person of adult size is sitting in the front passenger's seat, but the "passenger airbag off" or "pass airbag off" indicator lamp is lit, it is possible that the person isn't sitting properly in the seat. If this happens:

- Turn the vehicle off and ask the person to place the seatback in the full upright position.
- Have the person sit upright in the seat, centered on the seat cushion, with the person's legs comfortably extended.

Seating and Safety Restraints

- Restart the vehicle and have the person remain in this position for about two minutes. This will allow the system to detect that person and enable the passenger's frontal airbag.
- If the indicator lamp remains lit even after this, the person should be advised to ride in the rear seat.

Occupant	Pass Airbag Off Indicator Lamp	Passenger Airbag
Empty seat	Unlit	Disabled
Small child in child safety seat or booster	Lit	Disabled
Small child with safety belt buckled or unbuckled	Lit	Disabled
Adult	Unlit	Enabled

 **WARNING:** Even with Advanced Restraints Systems, children 12 and under should be properly restrained in a rear seating position.

After all occupants have adjusted their seats and put on safety belts, it's very important that they continue to sit properly. A properly seated occupant sits upright, leaning against the seat back, and centered on the seat cushion, with their feet comfortably extended on the floor. Sitting improperly can increase the chance of injury in a crash event. For example, if an occupant slouches, lies down, turns sideways, sits forward, leans forward or sideways, or puts one or both feet up, the chance of injury during a crash is greatly increased.

 **WARNING:** Sitting improperly out of position or with the seat back reclined too far can take off weight from the seat cushion and affect the decision of the front passenger sensing system, resulting in serious injury or death in a crash. Always sit upright against your seatback, with your feet on the floor.

The front passenger sensing system may detect small or medium objects placed on the seat cushion. For most objects that are in the front passenger seat, the passenger airbag will be disabled. Even though the passenger airbag is disabled, the "pass airbag off" lamp may or may not be illuminated according to the table below.

Seating and Safety Restraints

Objects	Pass Airbag Off Indicator Lamp	Passenger Airbag
Small (i.e. three-ring binder, small purse, bottled water)	Unlit	Disabled
Medium (i.e. heavy briefcase, fully packed luggage)	Lit	Disabled
Empty seat, or small to medium object with safety belt buckled	Lit	Disabled

If you think that the status of the passenger airbag off indicator lamp is incorrect, check for the following:

- Objects lodged underneath the seat
- Objects between the seat cushion and the center console (if equipped)
- Objects hanging off the seat back
- Objects stowed in the seatback map pocket (if equipped)
- Objects placed on the occupant's lap
- Cargo interference with the seat
- Other passengers pushing or pulling on the seat
- Rear passenger feet and knees resting or pushing on the seat

The conditions listed above may cause the weight of a properly seated occupant to be incorrectly interpreted by the front passenger sensing system. The person in the front passenger seat may appear heavier or lighter due to the conditions described in the list above.



WARNING: To reduce the risk of possible serious injury:

Do not stow objects in seat back map pocket (if equipped) or hang objects off seat back if a child is in the front passenger seat. Do not place objects underneath the front passenger seat or between the seat and the center console (if equipped). Check the “passenger airbag off” or “pass airbag off” indicator lamp for proper airbag Status. Failure to follow these instructions may interfere with the front passenger seat sensing system.

Seating and Safety Restraints

In case there is a problem with the front passenger sensing system, the airbag readiness lamp in the instrument cluster will stay lit.



If the airbag readiness lamp is lit, do the following:

The driver and/or adult passengers should check for any objects that may be lodged underneath the front passenger seat or cargo interfering with the seat.

If objects are lodged and/or cargo is interfering with the seat; please take the following steps to remove the obstruction:

- Pull the vehicle over.
- Turn the vehicle off.
- Driver and/or adult passengers should check for any objects lodged underneath the front passenger seat or cargo interfering with the seat.
- Remove the obstruction(s) (if found).
- Restart the vehicle.
- Wait at least two minutes and verify that the airbag readiness lamp is no longer illuminated
- If the airbag readiness lamp remains illuminated, this may or may/not be a problem due to the front passenger sensing system.

DO NOT attempt to repair or service the system; take your vehicle immediately to an authorized dealer.



WARNING: The front passenger airbag is not designed to offer protection to an occupant in the center seating position.



WARNING: An out of position front center occupant could affect the decision of the front passenger sensing system.

If it is necessary to modify an advanced front airbag system to accommodate a person with disabilities, contact the Ford Customer Relationship Center at the phone number shown in the *Customer Assistance* section of this *Owner's Guide*.



WARNING: Any alteration/modification to the front passenger seat may affect the performance of the front passenger sensing system.

Seating and Safety Restraints

Determining if the system is operational

The SRS uses a readiness light in the instrument cluster or a tone to indicate the condition of the system. Refer to *Airbag readiness* section in the *Instrument Cluster* chapter. Routine maintenance of the airbag is not required.

A difficulty with the system is indicated by one or more of the following:

- The readiness light will either flash or stay lit.
- The readiness light will not illuminate immediately after ignition is turned on.
- A series of five beeps will be heard. The tone pattern will repeat periodically until the problem and/or light are repaired.



If any of these things happen, even intermittently, contact your authorized dealer as soon as possible. Unless serviced, the system may not function properly in the event of a collision.

Seat-mounted side airbag system



WARNING: Do not place objects or mount equipment on or near the airbag cover on the side of the seatbacks of the front seats or in front seat areas that may come into contact with a deploying airbag. Failure to follow these instructions may increase the risk of personal injury in the event of a collision.



WARNING: Do not use accessory seat covers. The use of accessory seat covers may prevent the deployment of the side airbags and increase the risk of injury in an accident.



WARNING: Do not lean your head on the door. The side airbag could injure you as it deploys from the side of the seatback.



WARNING: Do not attempt to service, repair, or modify the airbag SRS, its fuses or the seat cover on a seat containing an airbag. Contact your authorized dealer as soon as possible.

Seating and Safety Restraints



WARNING: All occupants of the vehicle should always wear their safety belts even when an airbag SRS is provided.

How does the side airbag system work?

The design and development of the side airbag system included recommended testing procedures that were developed by a group of automotive safety experts known as the Side Airbag Technical Working Group. These recommended testing procedures help reduce the risk of injuries related to the deployment of side airbags.

The side airbag system consists of the following:

- An inflatable nylon bag (airbag) with a gas generator concealed behind the outboard bolster of the driver and front passenger seatbacks.
- A special seat cover designed to allow airbag deployment.
- The same warning light, electronic control and diagnostic unit as used for the front airbags.
- Two crash sensors located near the side of the vehicle.

Side airbags, in combination with safety belts, can help reduce the risk of severe injuries in the event of a significant side impact collision.

The side airbags are fitted on the outboard side of the seatbacks of the front seats. In certain lateral collisions, the airbag on the side affected by the collision will be inflated. The airbag was designed to inflate between the door panel and occupant to further enhance the protection provided occupants in side impact collisions.

The airbag SRS is designed to activate when the vehicle sustains lateral deceleration sufficient to cause the sensors to close an electrical circuit that initiates airbag inflation.

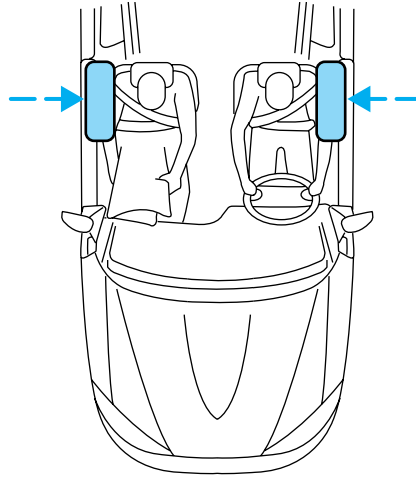

Seating and Safety Restraints

The fact that the airbags did not inflate in a collision does not mean that something is wrong with the system. Rather, it means the forces were not of the type sufficient to cause activation. Side airbags are designed to inflate in side-impact collisions, not roll-over, rear-impact, frontal or near-frontal collisions, unless the collision causes sufficient lateral deceleration.



WARNING: Several air bag system components get hot after inflation. Do not touch them after inflation.



WARNING: If the side airbag has deployed, **the airbag will not function again. The side airbag system (including the seat) must be inspected and serviced by an authorized dealer.** If the airbag is not replaced, the unrepaired area will increase the risk of injury in a collision.

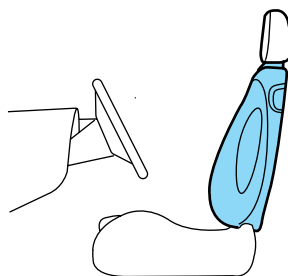

Determining if the system is operational

The SRS uses a readiness light in the instrument cluster or a tone to indicate the condition of the system. Refer to the *Airbag readiness* section in the *Instrument Cluster* chapter. Routine maintenance of the side airbag is not required.

A difficulty with the system is indicated by one or more of the following:

- The readiness light (same light as for front airbag system) will either flash or stay lit.
- The readiness light will not illuminate immediately after ignition is turned on.
- A series of five beeps will be heard. The tone pattern will repeat periodically until the problem and/or light are repaired.

If any of these things happen, even intermittently, have the SRS serviced at your authorized dealer immediately. Unless serviced, the system may not function properly in the event of a collision.

Seating and Safety Restraints

Disposal of airbags and airbag equipped vehicles (including pretensioners)

Contact your authorized dealer as soon as possible. Airbags MUST BE disposed of by qualified personnel.

SAFETY RESTRAINTS FOR CHILDREN

See the following sections for directions on how to properly use safety restraints for children. Also see *Airbag supplemental restraint system (SRS)* in this chapter for special instructions about using airbags.

Important child restraint precautions



WARNING: Always make sure your child is secured properly in a device that is appropriate for their height, age and weight. Child safety restraints must be purchased separately from the vehicle. Failure to follow these instructions and guidelines may result in an increased risk of serious injury or death to your child.



WARNING: All children are shaped differently. The Recommendations for Safety Restraints are based on probable child height, age and weight thresholds from NHTSA and other safety organizations or are the minimum requirements of law. Ford recommends checking with a NHTSA Certified Child Passenger Safety Technician (CPST) and your pediatrician to make sure your child seat is appropriate for your child, and is compatible with and properly installed in the vehicle. To locate a child seat fitting station and CPST contact the NHTSA toll free at 1-888-327-4236 or on the internet at <http://www.nhtsa.dot.gov>. Failure to properly restrain children in safety seats made especially for their height, age, and weight may result in an increased risk of serious injury or death to your child.

Seating and Safety Restraints

Recommendations for Safety Restraints for Children		
	Child size, height, weight, or age	Recommended restraint type
Infants or toddlers	Children weighing 40 lb (18 kg) or less (generally age four or younger)	Use a child safety seat (sometimes called an infant carrier, convertible seat, or toddler seat).
Small children	Children who have outgrown or no longer properly fit in a child safety seat (generally children who are less than 4 feet 9 inches (1.45 meters) tall, are greater than age four (4) and less than age twelve (12), and between 40 lbs (18 kg) and 80 lbs (36 kg) and upward to 100 lbs (45 kg) if recommended by your child restraint manufacturer)	Use a belt-positioning booster seat.
Larger children	Children who have outgrown or no longer properly fit in a belt-positioning booster seat (generally children who are at least 4 feet 9 inches (1.45 meters) tall or greater than 80 lb (36 kg) or 100 lb (45 kg) if recommended by child restraint manufacturer)	Use a vehicle safety belt having the lap belt snug and low across the hips, shoulder belt centered across the shoulder and chest, and seatback upright.

- You are required by law to properly use safety seats for infants and toddlers in the U.S. and Canada.
- Many states and provinces require that small children use approved booster seats until they reach age eight, a height of 4 ft 9 in (1.45 meters) tall, or 80 lb (36 kg). Check your local and state or provincial laws for specific requirements regarding the safety of children in your vehicle.
- When possible, always properly restrain children twelve (12) years of age and under in a rear seating position of your vehicle. Accident statistics suggest that children are safer when properly restrained in the rear seating positions than in a front seating position.

Seating and Safety Restraints

Recommendations for attaching child safety restraints for children

Restraint Type	Child Weight	Use any attachment method as indicated below by "X"				
		LATCH (lower anchors and top tether anchor)	LATCH (lower anchors only)	Safety belt and top tether anchor	Safety belt and LATCH (lower anchors and top tether anchor)	Safety belt only
Rear facing child seat	Up to 48 lb (21 kg)		X			X
Forward facing child seat	Up to 48 lb (21 kg)	X		X	X	
Forward facing child seat	Over 48 lb (21 kg)			X	X	



WARNING: Air bags can kill or injure a child in a child seat. NEVER place a rear-facing child seat in front of an active air bag. If you must use a forward-facing child seat in the front seat, move the vehicle seat all the way back. When possible, all children age 12 and under should be properly restrained in a rear seating position. If all children cannot be seated and restrained properly in a rear seating position, properly restrain the largest child in the front seat.



WARNING: Always carefully follow the instructions and warnings provided by the manufacturer of any child restraint to determine if the restraint device is appropriate for your child's size, height, weight, or age. Follow the child restraint manufacturer's instructions and warnings provided for installation and use in conjunction with the instructions and warnings provided by the vehicle manufacturer. A safety seat that is improperly installed or utilized, is inappropriate for your child's height, age, or weight or does not properly fit the child may increase the risk of serious injury or death.

Seating and Safety Restraints



WARNING: Never let a passenger hold a child on his or her lap while the vehicle is moving. The passenger cannot protect the child from injury in a collision, which may result in serious injury or death.



WARNING: Never use pillows, books, or towels to boost a child. They can slide around and increase the likelihood of injury or death in a collision.



WARNING: Always restrain an unoccupied child seat or booster seat. These objects may become projectiles in a collision or sudden stop, which may increase the risk of serious injury.



WARNING: Never place, or allow a child to place, the shoulder belt under a child's arm or behind the back because it reduces the protection for the upper part of the body and may increase the risk of injury or death in a collision.



WARNING: Do not leave children, unreliable adults, or pets unattended in your vehicle.

Transporting children

Always make sure your child is secured properly in a device that is appropriate for their age, height and weight. All children are shaped differently. The child height, age and weight thresholds provided are recommendations or the minimum requirements of law. The National Highway Traffic Safety Administration (NHTSA) provides education and training to ensure that all children ages 0 to 16 are properly restrained in the correct restraint system. Ford recommends checking with a NHTSA Certified Child Passenger Safety Technician (CPST) and your pediatrician to make sure your seat is appropriate for your child and properly installed in the vehicle. To locate a child seat fitting station and CPST contact the NHTSA toll free at **1-888-327-4236** or on the internet at <http://www.nhtsa.dot.gov>.

Follow all the safety restraint and airbag precautions that apply to adult passengers in your vehicle.

Seating and Safety Restraints

If the child is the proper height, age, and weight (as specified by your child safety seat or booster manufacturer), fits the restraint and can be restrained properly, then restrain the child in the child safety seat or with the belt-positioning booster. Remember that child seats and belt-positioning boosters vary and may be designed to fit children of different heights, ages and weights. Children who are too large for child safety seats or belt-positioning boosters (as specified by your child safety seat manufacturer) should always properly wear safety belts.

SAFETY SEATS FOR CHILDREN

Infant and/or toddler seats

Use a safety seat that is recommended for the size and weight of the child.

When installing a child safety seat:

- Review and follow the information presented in the *Airbag supplemental restraint system (SRS)* section in this chapter.
- Carefully follow all of the manufacturer's instructions included with the safety seat you put in your vehicle. If you do not install and use the safety seat properly, the child may be injured in a sudden stop or collision.

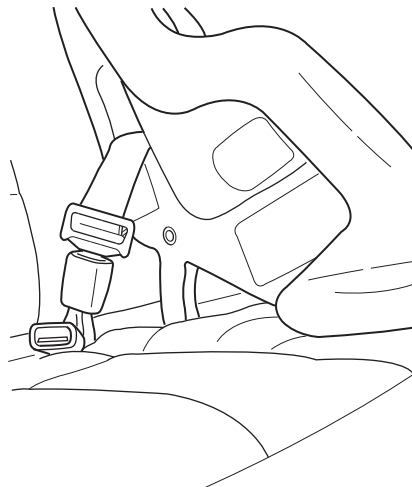

Airbags can kill or injure a child in a child seat. NEVER place a rear-facing child seat in front of an active airbag. If you must use a forward-facing child seat in the front seat, move the vehicle seat all the way back.

Children 12 and under should be properly restrained in a rear seating position whenever possible. If all children cannot be seated and restrained properly in a rear seating position, properly restrain the largest child in the front seat.

Seating and Safety Restraints

Installing child safety seats with combination lap and shoulder belts

Check to make sure the child seat is properly secured before each use. Children 12 and under should be properly restrained in a rear seating position whenever possible. If all children cannot be seated and restrained properly in a rear seating position, properly restrain the largest child in the front seat.

When installing a child safety seat with combination lap/shoulder belts:

- Use the correct safety belt buckle for that seating position.
- Insert the belt tongue into the proper buckle until you hear a snap and feel it latch. Make sure the tongue is securely fastened in the buckle.
- Keep the buckle release button pointing up and away from the safety seat, with the tongue between the child seat and the release button, to help prevent accidental unbuckling.
- Place vehicle seat back in upright position.
- Put the safety belt in the automatic locking mode. Refer to step 5 below.



WARNING: Depending on where you secure a child restraint, and depending on the child restraint design, you may block access to certain safety belt buckle assemblies and/or LATCH lower anchors, rendering those features potentially unusable. To avoid risk of injury, occupants should only use seating positions where they are able to be properly restrained.

Perform the following steps when installing the child seat with combination lap/shoulder belts:

Note: Although the child seat illustrated is a forward facing child seat, the steps are the same for installing a rear facing child seat.

Seating and Safety Restraints

1. Position the child safety seat in a seat with a combination lap and shoulder belt.

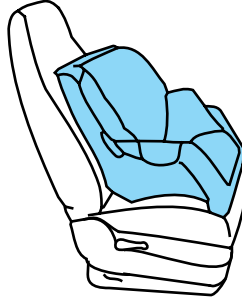

2. Pull down on the shoulder belt and then grasp the shoulder belt and lap belt together.

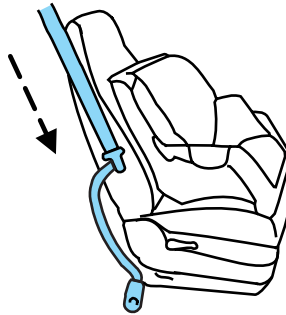

3. While holding the shoulder and lap belt portions together, route the tongue through the child seat according to the child seat manufacturer's instructions. Be sure the belt webbing is not twisted.

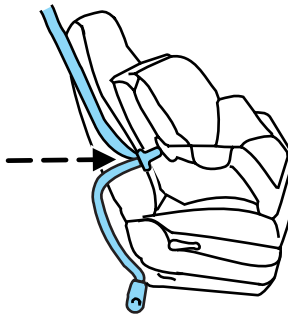

Seating and Safety Restraints

4. Insert the belt tongue into the proper buckle (the buckle closest to the direction the tongue is coming from) for that seating position until you hear a snap and feel the latch engage. Make sure the tongue is latched securely by pulling on it.

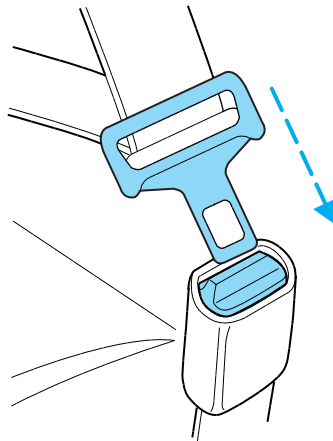

5. To put the retractor in the automatic locking mode, grasp the shoulder portion of the belt and pull downward until all of the belt is pulled out.

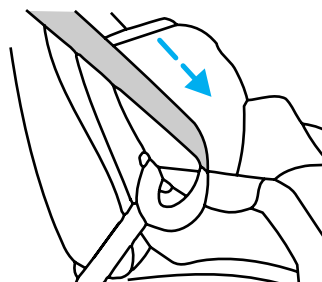

6. Allow the belt to retract to remove slack. The belt will click as it retracts to indicate it is in the automatic locking mode.

7. Try to pull the belt out of the retractor to make sure the retractor is in the automatic locking mode (you should not be able to pull more belt out). If the retractor is not locked, repeat Steps 5 and 6.

Seating and Safety Restraints

8. Remove remaining slack from the belt. Force the seat down with extra weight, e.g., by pressing down or kneeling on the child restraint while pulling up on the shoulder belt in order to force slack from the belt. This is necessary to remove the remaining slack that will exist once the additional weight of the child is added to the child restraint. It also helps to achieve the proper snugness of the child seat to the vehicle. Sometimes, a slight lean towards the buckle will additionally help to remove remaining slack from the belt.

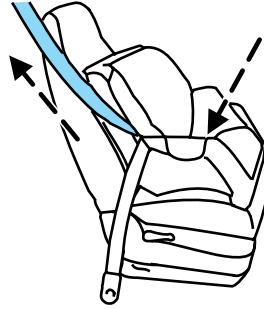

9. Attach the tether strap (if the child seat is equipped). Refer to *Attaching child safety seats with tether straps* later in this chapter.

10. Before placing the child in the seat, forcibly move the seat forward and back to make sure the seat is securely held in place. To check this, grab the seat at the belt path and attempt to move it side to side and forward and back. There should be no more than 1 inch (2.5 cm) of movement for proper installation.

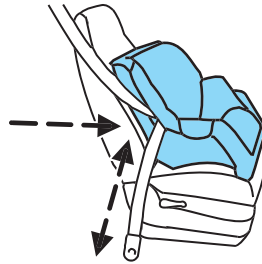

11. Ford recommends checking with a NHTSA Certified Child Passenger Safety Technician (CPST) to make certain the child restraint is properly installed.

Installing child safety seats in the lap belt seating positions



WARNING: Installing a child safety seat in the front row lap seating position should be avoided if at all possible.



WARNING: Never place a rear-facing child seat in the front center seating position of a vehicle with rear seating positions.

Seating and Safety Restraints



WARNING: Front seating positions only: If seating two adults and a child, Ford recommends properly restraining the child in the center front seating position, but only if doing so will not interfere with driving the vehicle. This arrangement provides lap and shoulder belt and airbag protection for adult occupants and an attachment method for a child restraint. If the child seat interferes with driving the vehicle and the child restraint is forward-facing, the child may be restrained in the passenger seat. Move the seat as far rearward as possible to minimize the likelihood of interaction with the front passenger airbag. Never place a rear-facing child seat in front of an active airbag. All occupants of the vehicle should always properly wear their safety belts. Ensure the child is properly restrained in an appropriate child seat or with the use of a booster.

1. Lengthen the lap belt. To lengthen the belt, hold the tongue so that its bottom is perpendicular to the direction of webbing while sliding the tongue up the webbing.
2. Place the child safety seat in the center seating position.
3. Route the tongue and webbing through the child seat according to the child seat manufacturer's instructions.
4. Insert the belt tongue into the proper buckle for the center seating position until you hear a snap and feel it latch. Make sure the tongue is securely fastened to the buckle by pulling on the tongue.
5. Push down on the child seat while pulling on the loose end of the lap belt webbing to tighten the belt.
6. Before placing the child into the child seat, forcibly tilt the child seat from side to side and in forward direction to make sure that the seat is securely held in place. To check this, grab the seat at the belt path and attempt to move it side to side and forward and back. There should be no more than one inch (2.5 cm) of movement for proper installation.
7. Ford recommends checking with a NHTSA Certified Child Passenger Safety Technician (CPST) to make certain the child restraint is properly installed.

Note: There is no top tether anchor for the front center seating position. See *Attaching child safety seats with tether straps* later in this chapter.

Attaching child safety seats with LATCH (Lower Anchors and Tethers for Children) attachments

The LATCH system is composed of three vehicle anchor points: two (2) lower anchors located where the vehicle seat back and seat cushion meet (called the "seat bight") and one (1) top tether anchor located behind that seating position.

Seating and Safety Restraints

LATCH compatible child safety seats have two rigid or webbing mounted attachments that connect to the two lower anchors at the LATCH equipped seating positions in your vehicle. This type of attachment method eliminates the need to use safety belts to attach the child seat, however the safety belt can still be used to attach the child seat. For forward-facing child seats, the top tether strap must also be attached to the proper top tether anchor, if a top tether strap has been provided with your child seat. Ford Motor Company recommends the use of a child safety seat having a top tether strap. See *Attaching child safety seats with tether straps* and *Recommendations for attaching safety restraints for children* in this chapter for more information.

Your vehicle has LATCH lower anchors for child seat installation at the seating positions marked with the child seat symbol.

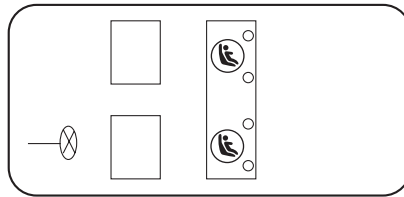

The LATCH anchors are located at the rear section of the rear seat between the cushion and seatback. Follow the child seat manufacturer's instructions to properly install a child seat with LATCH attachments.

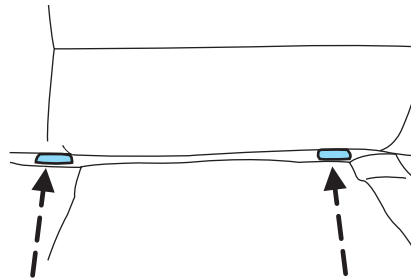

Follow the instructions on attaching child safety seats with tether straps. Refer to *Attaching child safety seats with tether straps* later in this chapter.

Attach LATCH lower attachments of the child seat only to the anchors shown.



WARNING: Never attach two child safety seats to the same anchor. In a crash, one anchor may not be strong enough to hold two child safety seat attachments and may break, causing serious injury or death.

Seating and Safety Restraints



WARNING: Depending on where you secure a child restraint, and depending on the child restraint design, you may block access to certain safety belt buckle assemblies and/or LATCH lower anchors, rendering those features potentially unusable. To avoid risk of injury, occupants should only use seating positions where they are able to be properly restrained.

Use of inboard lower anchors from the outboard seating positions (center seating use)

The lower anchors at the center of the second row rear seat are spaced 578 mm (23 inches) apart. The standardized spacing for LATCH lower anchors is 280 mm (11 inches) center to center. A child seat with rigid LATCH attachments cannot be installed at the center seating position. LATCH compatible child seats (with attachments on belt webbing) can only be used at this seating position provided that the child seat manufacturer's instructions permit use with the anchor spacing stated. Do not attach a child seat to any lower anchor if an adjacent child seat is attached to that anchor.



WARNING: The standardized spacing for LATCH lower anchors is 280 mm (11 inches) center to center. Do not use LATCH lower anchors for the center seating position unless the child seat manufacturer's instructions permit and specify using anchors spaced at least as far apart as those in this vehicle.

If you install a child seat with rigid LATCH attachments, and have attached the top tether strap to the proper top tether anchor, do not tighten the tether strap enough to lift the child seat off the vehicle seat cushion when the child is seated in it. Keep the tether strap just snug without lifting the front of the child seat. Keeping the child seat just touching the vehicle seat gives the best protection in a severe crash.

Each time you use the safety seat, check that the seat is properly attached to the lower anchors and tether anchor, if applicable. Tug the child seat from side to side and forward and back where it is secured to the vehicle. The seat should move less than one inch when you do this for a proper installation.

If the safety seat is not anchored properly, the risk of a child being injured in a crash greatly increases.

Seating and Safety Restraints

Combining safety belt and LATCH lower anchors for attaching child safety seats

When used in combination, either the safety belt or the LATCH lower anchors may be attached first, provided a proper installation is achieved. Attach the tether strap afterward, if included with the child seat. Refer to *Recommendations for attaching child safety restraints for children* in this chapter.

Attaching child safety seats with tether straps

Many forward-facing child safety seats include a tether strap which extends from the back of the child safety seat and hooks to an anchoring point called the top tether anchor. Tether straps are available as an accessory for many older safety seats. Contact the manufacturer of your child seat for information about ordering a tether strap, or to obtain a longer tether strap if the tether strap on your safety seat does not reach the appropriate top tether anchor in the vehicle.

The rear seats of your vehicle are equipped with built-in tether strap anchors located behind the seats as described below.

The tether anchors in your vehicle are located under a cover marked with the tether anchor symbol (shown with title).

The tether strap anchors in your vehicle are in the following positions (shown from top view):

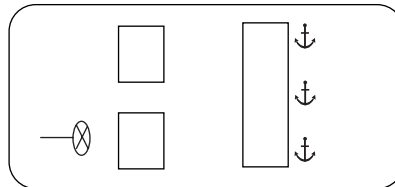

Attach the tether strap only to the appropriate tether anchor as shown. The tether strap may not work properly if attached somewhere other than the correct tether anchor.

Once the child safety seat has been installed, using either the safety belt, the lower anchors of the LATCH system, or both, you can attach the top tether strap.

Perform the following steps to install a child safety seat to the tether anchor:

1. Route the child safety seat tether strap over the back of the seat.

For vehicles with adjustable head restraints, route the tether strap under the head restraint and between the head restraint posts, otherwise route the tether strap over the top of the seatback.

Seating and Safety Restraints

2. Locate the correct anchor for the selected seating position.



3. Open the tether anchor cover.

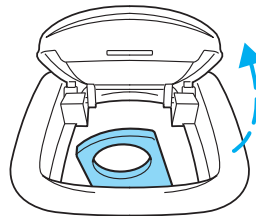

4. Clip the tether strap to the anchor as shown.

If the tether strap is clipped incorrectly, the child safety seat may not be retained properly in the event of a collision.

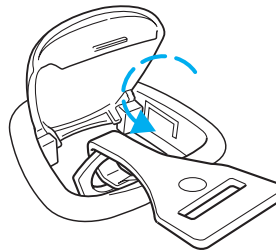

5. Tighten the child safety seat tether strap according to the manufacturer's instructions.

If the safety seat is not anchored properly, the risk of a child being injured in a collision greatly increases.

Child booster seats

The belt-positioning booster (booster seat) is used to improve the fit of the vehicle safety belt. Children outgrow a typical child seat (e.g., convertible or toddler seat) when they weigh about 40 lb (18 kg) and are around four (4) years of age. Consult your child safety seat owner guide for the weight, height, and age limits specific to your child safety seat. Keep your child in the child safety seat if it properly fits the child, remains appropriate for their weight, height and age AND if properly secured to the vehicle.

Seating and Safety Restraints

Although the lap/shoulder belt will provide some protection, children who have outgrown a typical child seat are still too small for lap/shoulder belts to fit properly, and wearing an improperly fitted vehicle safety belt could increase the risk of serious injury in a crash. To improve the fit of both the lap and shoulder belt on children who have outgrown child safety seats, Ford Motor Company recommends use of a belt-positioning booster.

Booster seats position a child so that vehicle lap/shoulder safety belts fit better. They lift the child up so that the lap belt rests low across the hips and the knees bend comfortably at the edge of the cushion, while minimizing slouching. Booster seats may also make the shoulder belt fit better and more comfortably. Try to keep the belt near the middle of the shoulder and across the center of the chest. Moving the child closer (a few centimeters or inches) to the center of the vehicle, but remaining in the same seating position, may help provide a good shoulder belt fit.

When children should use booster seats

Children need to use booster seats from the time they outgrow the toddler seat until they are big enough for the vehicle seat and lap/shoulder belt to fit properly. Generally this is when they reach a height of at least 4 feet 9 inches (1.45 meters) tall (around age eight to age twelve and between 40 lb (18 kg) and 80 lb (36 kg) or upward to 100 lb (45 kg) if recommended by your child restraint manufacturer). Many state and provincial laws require that children use approved booster seats until they reach age eight, a height of 4 feet 9 inches (1.45 meters) tall, or 80 lb (36 kg).

Booster seats should be used until you can answer YES to ALL of these questions when seated without a booster seat:

- Can the child sit all the way back against the vehicle seat back with knees bent comfortably at the edge of the seat cushion?
- Can the child sit without slouching?

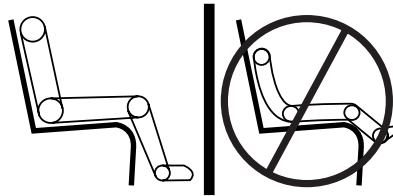

- Does the lap belt rest low across the hips?
- Is the shoulder belt centered on the shoulder and chest?
- Can the child stay seated like this for the whole trip?

Seating and Safety Restraints

Types of booster seats

There are generally two types of belt-positioning booster seats: backless and high back. Always use booster seats in conjunction with the vehicle lap/shoulder belt.

- **Backless booster seats**

If your backless booster seat has a removable shield, remove the shield. If a vehicle seating position has a low seat back or no head restraint, a backless booster seat may place your child's head (as measured at the tops of the ears) above the top of the seat. In this case, move the backless booster to another seating position with a higher seat back or head restraint and lap/shoulder belts, or consider using a high back booster seat.



- **High back booster seats**

If, with a backless booster seat, you cannot find a seating position that adequately supports your child's head, a high back booster seat would be a better choice.



Seating and Safety Restraints

Children and booster seats vary in size and shape. Choose a booster that keeps the lap belt low and snug across the hips, never up across the stomach, and lets you adjust the shoulder belt to cross the chest and rest snugly near the center of the shoulder. The drawings below compare the ideal fit (center) to a shoulder belt uncomfortably close to the neck and a shoulder belt that could slip off the shoulder. The drawings below also show how the lap belt should be low and snug across the child's hips.

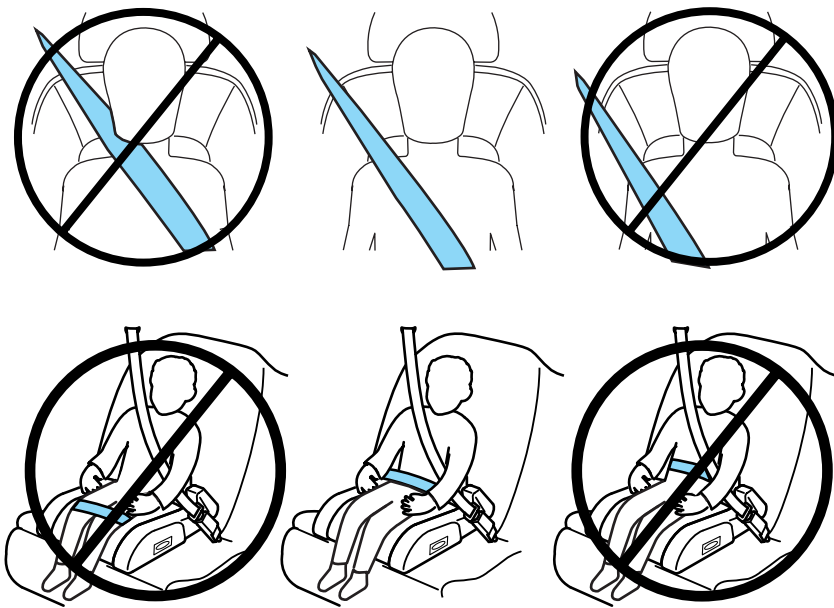

If the booster seat slides on the vehicle seat, placing a rubberized mesh sold as shelf or carpet liner under the booster seat may improve this condition. Do not introduce any item thicker than this under the booster seat. Check with the booster seat manufacturer's instructions.

The importance of shoulder belts

Using a booster without a shoulder belt increases the risk of a child's head hitting a hard surface in a collision. For this reason, you should never use a booster seat with a lap belt only. It is generally best to use a booster seat with lap/shoulder belts in the back seat.

Seating and Safety Restraints

Move a child to a different seating location if the shoulder belt does not stay positioned on the shoulder during use.

Follow all instructions provided by the manufacturer of the booster seat.



WARNING: Never place, or allow a child to place, the shoulder belt under a child's arm or behind the back because it reduces the protection for the upper part of the body and may increase the risk of injury or death in a collision.

Child restraint and safety belt maintenance

Inspect the vehicle safety belts and child safety seat systems periodically to make sure they work properly and are not damaged. Inspect the vehicle and child seat safety belts to make sure there are no nicks, tears or cuts. Replace if necessary. All vehicle safety belt assemblies, including retractors, buckles, front safety belt buckle assemblies, buckle support assemblies (slide bar-if equipped), shoulder belt height adjusters (if equipped), shoulder belt guide on seatback (if equipped), child safety seat LATCH and tether anchors, and attaching hardware, should be inspected after a collision. Refer to the child restraint manufacturer's instructions for additional inspection and maintenance information specific to the child restraint. Ford Motor Company recommends that all safety belt assemblies in use in vehicles involved in a collision be replaced. However, if the collision was minor and an authorized dealer finds that the belts do not show damage and continue to operate properly, they do not need to be replaced. Safety belt assemblies not in use during a collision should also be inspected and replaced if either damage or improper operation is noted.

For proper care of soiled safety belts, refer to *Interior* in the *Cleaning* chapter.



WARNING: Failure to inspect and if necessary replace the safety belt assembly or child restraint system under the above conditions could result in severe personal injuries in the event of a collision.

Tires, Wheels and Loading

INFORMATION ABOUT UNIFORM TIRE QUALITY GRADING

Tire Quality Grades apply to new pneumatic passenger car tires. The Quality grades can be found where applicable on the tire sidewall between tread shoulder and maximum section width. For example:

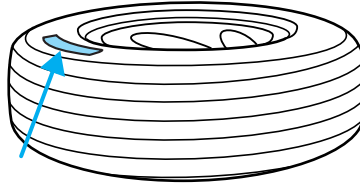

- **Treadwear 200 Traction AA Temperature A**

These Tire Quality Grades are determined by standards that the United States Department of Transportation has set.

Tire Quality Grades apply to new pneumatic passenger car tires. They do not apply to deep tread, winter-type snow tires, space-saver or temporary use spare tires, light truck or “LT” type tires, tires with nominal rim diameters of 10 to 12 inches or limited production tires as defined in Title 49 Code of Federal Regulations Part 575.104(c)(2).

U.S. Department of Transportation-Tire quality grades: The U.S. Department of Transportation requires Ford Motor Company to give you the following information about tire grades exactly as the government has written it.

Treadwear

The treadwear grade is a comparative rating based on the wear rate of the tire when tested under controlled conditions on a specified government test course. For example, a tire graded 150 would wear one and one-half (1½) times as well on the government course as a tire graded 100. The relative performance of tires depends upon the actual conditions of their use, however, and may depart significantly from the norm due to variations in driving habits, service practices, and differences in road characteristics and climate.

Traction AA A B C

The traction grades, from highest to lowest are AA, A, B, and C. The grades represent the tire’s ability to stop on wet pavement as measured under controlled conditions on specified government test surfaces of asphalt and concrete. A tire marked C may have poor traction performance.

Tires, Wheels and Loading



WARNING: The traction grade assigned to this tire is based on straight-ahead braking traction tests, and does not include acceleration, cornering, hydroplaning or peak traction characteristics.

Temperature A B C

The temperature grades are A (the highest), B and C, representing the tire's resistance to the generation of heat and its ability to dissipate heat when tested under controlled conditions on a specified indoor laboratory test wheel. Sustained high temperature can cause the material of the tire to degenerate and reduce tire life, and excessive temperature can lead to sudden tire failure. The grade C corresponds to a level of performance which all passenger car tires must meet under the Federal Motor Vehicle Safety Standard No. 139. Grades B and A represent higher levels of performance on the laboratory test wheel than the minimum required by law.



WARNING: The temperature grade for this tire is established for a tire that is properly inflated and not overloaded. Excessive speed, underinflation, or excessive loading, either separately or in combination, can cause heat buildup and possible tire failure.

TIRES

Tires are designed to give many thousands of miles of service, but they must be maintained in order to get the maximum benefit from them.

Glossary of tire terminology

- **Tire label:** A label showing the OE (Original Equipment) tire sizes, recommended inflation pressure and the maximum weight the vehicle can carry.
- **Tire Identification Number (TIN):** A number on the sidewall of each tire providing information about the tire brand and manufacturing plant, tire size and date of manufacture. Also referred to as DOT code.
- **Inflation pressure:** A measure of the amount of air in a tire.
- **Standard load:** A class of P-metric or Metric tires designed to carry a maximum load at 35 psi [37 psi (2.5 bar) for Metric tires]. Increasing the inflation pressure beyond this pressure will not increase the tire's load carrying capability.
- **Extra load:** A class of P-metric or Metric tires designed to carry a heavier maximum load at 41 psi [43 psi (2.9 bar) for Metric tires].

Tires, Wheels and Loading

Increasing the inflation pressure beyond this pressure will not increase the tire's load carrying capability.

- **kPa:** Kilopascal, a metric unit of air pressure.
- **PSI:** Pounds per square inch, a standard unit of air pressure.
- **Cold inflation pressure:** The tire pressure when the vehicle has been stationary and out of direct sunlight for an hour or more and prior to the vehicle being driven for 1 mile (1.6 km).
- **Recommended inflation pressure:** The cold inflation pressure found on the Safety Compliance Certification Label or Tire Label located on the B-Pillar or the edge of the driver's door.
- **B-pillar:** The structural member at the side of the vehicle behind the front door.
- **Bead area of the tire:** Area of the tire next to the rim.
- **Sidewall of the tire:** Area between the bead area and the tread.
- **Tread area of the tire:** Area of the perimeter of the tire that contacts the road when mounted on the vehicle.
- **Rim:** The metal support (wheel) for a tire or a tire and tube assembly upon which the tire beads are seated.

INFLATING YOUR TIRES

Safe operation of your vehicle requires that your tires are properly inflated. Remember that a tire can lose up to half of its air pressure without appearing flat.

Every day before you drive, check your tires. If one looks lower than the others, use a tire gauge to check pressure of all tires and adjust if required.

At least once a month and before long trips, inspect each tire and check the tire pressure with a tire gauge (including spare, if equipped). Inflate all tires to the inflation pressure recommended by Ford Motor Company.

You are strongly urged to buy a reliable tire pressure gauge, as automatic service station gauges may be inaccurate. Ford recommends the use of a digital or dial-type tire pressure gauge rather than a stick-type tire pressure gauge.

Use the recommended cold inflation pressure for optimum tire performance and wear. Under-inflation or over-inflation may cause uneven treadwear patterns.

Tires, Wheels and Loading



WARNING: Under-inflation is the most common cause of tire failures and may result in severe tire cracking, tread separation or "blowout", with unexpected loss of vehicle control and increased risk of injury. Under-inflation increases sidewall flexing and rolling resistance, resulting in heat buildup and internal damage to the tire. It also may result in unnecessary tire stress, irregular wear, loss of vehicle control and accidents. A tire can lose up to half of its air pressure and not appear to be flat!

Always inflate your tires to the Ford recommended inflation pressure even if it is less than the maximum inflation pressure information found on the tire. The Ford recommended tire inflation pressure is found on the Safety Compliance Certification Label or Tire Label which is located on the B-Pillar or the edge of the driver's door. Failure to follow the tire pressure recommendations can cause uneven treadwear patterns and adversely affect the way your vehicle handles.

Maximum Permissible Inflation Pressure is the tire manufacturer's maximum permissible pressure and/or the pressure at which the maximum load can be carried by the tire. This pressure is normally higher than the manufacturer's recommended cold inflation pressure which can be found on the Safety Compliance Certification Label or Tire Label which is located on the B-Pillar or the edge of the driver's door. The cold inflation pressure should never be set lower than the recommended pressure on the Safety Compliance Certification Label or Tire Label.

When weather temperature changes occur, tire inflation pressures also change. A 10°F (6°C) temperature drop can cause a corresponding drop of 1 psi (7 kPa) in inflation pressure. Check your tire pressures frequently and adjust them to the proper pressure which can be found on the Safety Compliance Certification Label or Tire Label.

To check the pressure in your tire(s):

1. Make sure the tires are cool, meaning they are not hot from driving even a mile.

If you are checking tire pressure when the tire is hot, (i.e. driven more than 1 mile [1.6 km]), never "bleed" or reduce air pressure. The tires are hot from driving and it is normal for pressures to increase above recommended cold pressures. A hot tire at or below recommended cold inflation pressure could be significantly under-inflated.

Tires, Wheels and Loading

Note: If you have to drive a distance to get air for your tire(s), check and record the tire pressure first and add the appropriate air pressure when you get to the pump. It is normal for tires to heat up and the air pressure inside to go up as you drive.

2. Remove the cap from the valve on one tire, then firmly press the tire gauge onto the valve and measure the pressure.

3. Add enough air to reach the recommended air pressure.

Note: If you overfill the tire, release air by pushing on the metal stem in the center of the valve. Then recheck the pressure with your tire gauge.

4. Replace the valve cap.

5. Repeat this procedure for each tire, including the spare.

Note: Some spare tires operate at a higher inflation pressure than the other tires. For T-type/mini-spare tires (see the *Dissimilar spare tire/wheel information* section for description): Store and maintain at 60 psi (4.15 bar). For Full Size and Dissimilar spare tires (see the *Dissimilar spare tire/wheel information* section for description): Store and maintain at the higher of the front and rear inflation pressure as shown on the Tire Label.

6. Visually inspect the tires to make sure there are no nails or other objects embedded that could poke a hole in the tire and cause an air leak.

7. Check the sidewalls to make sure there are no gouges, cuts or bulges.

TIRE CARE

Inspecting your tires

Periodically inspect the tire treads for uneven or excessive wear and remove objects such as stones, nails or glass that may be wedged in the tread grooves. Check for holes or cuts that may permit air leakage from the tire and make necessary repairs. Also inspect the tire sidewalls for cracking, cuts, bruises and other signs of damage or excessive wear. If internal damage to the tire is suspected, have the tire demounted and inspected in case it needs to be repaired or replaced. For your safety, tires that are damaged or show signs of excessive wear should not be used because they are more likely to blow out or fail.

Tires, Wheels and Loading

Improper or inadequate vehicle maintenance can cause tires to wear abnormally. Inspect all your tires, including the spare, frequently, and replace them if one or more of the following conditions exist:

Tire wear

When the tread is worn down to 1/16th of an inch (2 mm), tires must be replaced to help prevent your vehicle from skidding and hydroplaning. Built-in treadwear indicators, or “wear bars”, which look like narrow strips of smooth rubber across the tread will appear on the tire when the tread is worn down to 1/16th of an inch (2 mm).

When the tire tread wears down to the same height as these “wear bars”, the tire is worn out and must be replaced.

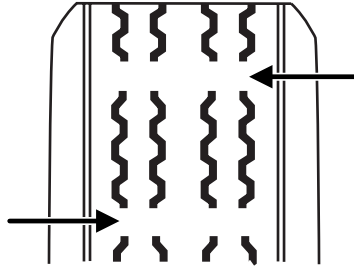

Damage

Periodically inspect the tire treads and sidewalls for damage (such as bulges in the tread or sidewalls, cracks in the tread groove and separation in the tread or sidewall). If damage is observed or suspected have the tire inspected by a tire professional. Tires can be damaged during off-road use, so inspection after off-road use is also recommended.



WARNING: Age

Tires degrade over time depending on many factors such as weather, storage conditions, and conditions of use (load, speed, inflation pressure, etc.) the tires experience throughout their lives. In general, tires should be replaced after six years regardless of tread wear. However, heat caused by hot climates or frequent high loading conditions can accelerate the aging process and may require tires to be replaced more frequently.

You should replace your spare tire when you replace the road tires or after six years due to aging even if it has not been used.

Tires, Wheels and Loading

U.S. DOT Tire Identification Number (TIN)

Both U.S. and Canada Federal regulations require tire manufacturers to place standardized information on the sidewall of all tires. This information identifies and describes the fundamental characteristics of the tire and also provides a U.S. DOT Tire Identification Number for safety standard certification and in case of a recall.

This begins with the letters "DOT" and indicates that the tire meets all federal standards. The next two numbers or letters are the plant code designating where it was manufactured, the next two are the tire size code and the last four numbers represent the week and year the tire was built. For example, the numbers 317 mean the 31st week of 1997. After 2000 the numbers go to four digits. For example, 2501 means the 25th week of 2001. The numbers in between are identification codes used for traceability. This information is used to contact customers if a tire defect requires a recall.

Tire replacement requirements

Your vehicle is equipped with tires designed to provide a safe ride and handling capability.



WARNING: Only use replacement tires and wheels that are the same size, load index, speed rating and type (such as P-metric versus LT-metric or all-season versus all-terrain) as those originally provided by Ford. The recommended tire and wheel size may be found on either the Safety Compliance Certification Label or the Tire Label which is located on the B-Pillar or edge of the driver's door. If this information is not found on these labels then you should contact your authorized dealer as soon as possible. Use of any tire or wheel not recommended by Ford can affect the safety and performance of your vehicle, which could result in an increased risk of loss of vehicle control, vehicle rollover, personal injury and death. Additionally the use of non-recommended tires and wheels could cause steering, suspension, axle or transfer case/power transfer unit failure. If you have questions regarding tire replacement, contact your authorized dealer as soon as possible.

Tires, Wheels and Loading



WARNING: When mounting replacement tires and wheels, you should not exceed the maximum pressure indicated on the sidewall of the tire to set the beads without additional precautions listed below. If the beads do not seat at the maximum pressure indicated, re-lubricate and try again.

When inflating the tire for mounting pressures up to 20 psi (1.38 bar) greater than the maximum pressure on the tire sidewall, the following precautions must be taken to protect the person mounting the tire:

1. Make sure that you have the correct tire and wheel size.
2. Lubricate the tire bead and wheel bead seat area again.
3. Stand at a minimum of 12 ft. (3.66 m) away from the tire wheel assembly.
4. Use both eye and ear protection.

For a mounting pressure more than 20 psi (1.38 bar) greater than the maximum pressure, a Ford Dealer or other tire service professional should do the mounting.

Always inflate steel carcass tires with a remote air fill with the person inflating standing at a minimum of 12 ft. (3.66 m) away from the tire wheel assembly.

Important: Remember to replace the wheel valve stems when the road tires are replaced on your vehicle.

It is recommended that the two front tires or two rear tires generally be replaced as a pair.

The tire pressure sensors mounted in the wheels (originally installed on your vehicle) are not designed to be used in aftermarket wheels.

The use of wheels or tires not recommended by Ford Motor Company may affect the operation of your Tire Pressure Monitoring System.

If the TPMS indicator is flashing, your TPMS is malfunctioning. Your replacement tire might be incompatible with your TPMS, or some component of the TPMS may be damaged.

Safety practices

Driving habits have a great deal to do with your tire mileage and safety.

- Observe posted speed limits
- Avoid fast starts, stops and turns
- Avoid potholes and objects on the road

Tires, Wheels and Loading

- Do not run over curbs or hit the tire against a curb when parking



WARNING: If your vehicle is stuck in snow, mud, sand, etc., **do not** rapidly spin the tires; spinning the tires can tear the tire and cause an explosion. A tire can explode in as little as three to five seconds.



WARNING: Do not spin the wheels at over 35 mph (56 km/h). The tires may fail and injure a passenger or bystander.

Highway hazards

No matter how carefully you drive there's always the possibility that you may eventually have a flat tire on the highway. Drive slowly to the closest safe area out of traffic. This may further damage the flat tire, but your safety is more important.

If you feel a sudden vibration or ride disturbance while driving, or you suspect your tire or vehicle has been damaged, immediately reduce your speed. Drive with caution until you can safely pull off the road. Stop and inspect the tires for damage. If a tire is under-inflated or damaged, deflate it, remove wheel and replace it with your spare tire and wheel. If you cannot detect a cause, have the vehicle towed to the nearest repair facility or tire dealer to have the vehicle inspected.

Tire and wheel alignment

A bad jolt from hitting a curb or pothole can cause the front end of your vehicle to become misaligned or cause damage to your tires. If your vehicle seems to pull to one side when you're driving, the wheels may be out of alignment. Have an authorized dealer check the wheel alignment periodically.

Wheel misalignment in the front or the rear can cause uneven and rapid treadwear of your tires and should be corrected by an authorized dealer. Front wheel drive (FWD) vehicles and those with an independent rear suspension (if equipped) may require alignment of all four wheels.

The tires should also be balanced periodically. An unbalanced tire and wheel assembly may result in irregular tire wear.

Tire rotation

Rotating your tires at the recommended interval (as indicated in the *scheduled maintenance information* that comes with your vehicle) will help your tires wear more evenly, providing better tire performance and longer tire life.

Tires, Wheels and Loading

- Rear Wheel Drive (RWD) vehicles/Four Wheel Drive (4WD)/All Wheel Drive (AWD) vehicles (front tires at top of diagram)

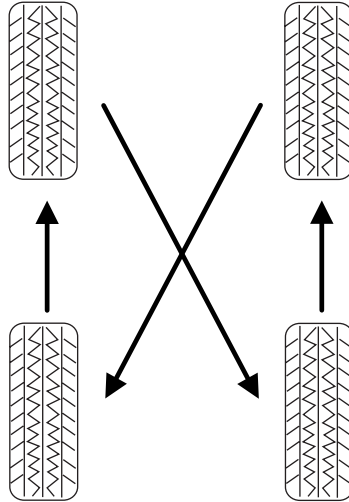

Sometimes irregular tire wear can be corrected by rotating the tires.

Note: If your tires show uneven wear ask an authorized dealer to check for and correct any wheel misalignment, tire imbalance or mechanical problem involved before tire rotation.

Note: Your vehicle may be equipped with a dissimilar spare tire/wheel. A dissimilar spare tire/wheel is defined as a spare tire and/or wheel that is different in brand, size or appearance from the road tires and wheels. If you have a dissimilar spare tire/wheel it is intended for temporary use only and should not be used in a tire rotation.

Note: After having your tires rotated, inflation pressure must be checked and adjusted to the vehicle requirements.

INFORMATION CONTAINED ON THE TIRE SIDEWALL

Both U.S. and Canada Federal regulations require tire manufacturers to place standardized information on the sidewall of all tires. This information identifies and describes the fundamental characteristics of the tire and also provides a U.S. DOT Tire Identification Number for safety standard certification and in case of a recall.

Tires, Wheels and Loading

Information on “P” type tires

P215/65R15 95H is an example of a tire size, load index and speed rating. The definitions of these items are listed below. (Note that the tire size, load index and speed rating for your vehicle may be different from this example.)

1. **P:** Indicates a tire, designated by the Tire and Rim Association (T&RA), that may be used for service on cars, SUVs, minivans and light trucks.

Note: If your tire size does not begin with a letter this may mean it is designated by either ETRTO (European Tire and Rim Technical Organization) or JATMA (Japan Tire Manufacturing Association).

2. **215:** Indicates the nominal width of the tire in millimeters from sidewall edge to sidewall edge. In general, the larger the number, the wider the tire.

3. **65:** Indicates the aspect ratio which gives the tire’s ratio of height to width.

4. **R:** Indicates a “radial” type tire.

5. **15:** Indicates the wheel or rim diameter in inches. If you change your wheel size, you will have to purchase new tires to match the new wheel diameter.

6. **95:** Indicates the tire’s load index. It is an index that relates to how much weight a tire can carry. You may find this information in your *Owner’s Guide*. If not, contact a local tire dealer.

Note: You may not find this information on all tires because it is not required by federal law.

7. **H:** Indicates the tire’s speed rating. The speed rating denotes the speed at which a tire is designed to be driven for extended periods of time under a standard condition of load and inflation pressure. The tires on your vehicle may operate at different conditions for load and inflation pressure. These speed ratings may need to be adjusted for the difference in conditions. The ratings range from 81 mph (130 km/h) to 186 mph (299 km/h). These ratings are listed in the following chart.

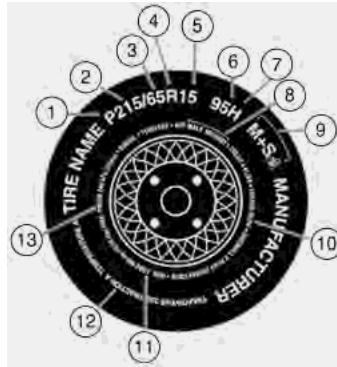

Tires, Wheels and Loading

Note: You may not find this information on all tires because it is not required by federal law.

Letter rating	Speed rating - mph (km/h)
M	81 mph (130 km/h)
N	87 mph (140 km/h)
Q	99 mph (159 km/h)
R	106 mph (171 km/h)
S	112 mph (180 km/h)
T	118 mph (190 km/h)
U	124 mph (200 km/h)
H	130 mph (210 km/h)
V	149 mph (240 km/h)
W	168 mph (270 km/h)
Y	186 mph (299 km/h)

Note: For tires with a maximum speed capability over 149 mph (240 km/h), tire manufacturers sometimes use the letters ZR. For those with a maximum speed capability over 186 mph (299 km/h), tire manufacturers always use the letters ZR.

8. U.S. DOT Tire Identification Number (TIN): This begins with the letters "DOT" and indicates that the tire meets all federal standards. The next two numbers or letters are the plant code designating where it was manufactured, the next two are the tire size code and the last four numbers represent the week and year the tire was built. For example, the numbers 317 mean the 31st week of 1997. After 2000 the numbers go to four digits. For example, 2501 means the 25th week of 2001. The numbers in between are identification codes used for traceability. This information is used to contact customers if a tire defect requires a recall.

9. M+S or M/S: Mud and Snow, or

AT: All Terrain, or

AS: All Season.

10. Tire Ply Composition and Material Used: Indicates the number of plies or the number of layers of rubber-coated fabric in the tire tread and sidewall. Tire manufacturers also must indicate the ply materials in the tire and the sidewall, which include steel, nylon, polyester, and others.

11. Maximum Load: Indicates the maximum load in kilograms and pounds that can be carried by the tire. Refer to the Safety Compliance Certification Label, which is located on the B-Pillar or the edge of the driver's door, for the correct tire pressure for your vehicle.

Tires, Wheels and Loading

12. Treadwear, Traction and Temperature Grades

- **Treadwear:** The treadwear grade is a comparative rating based on the wear rate of the tire when tested under controlled conditions on a specified government test course. For example, a tire graded 150 would wear one and one-half (1½) times as well on the government course as a tire graded 100.
- **Traction:** The traction grades, from highest to lowest are AA, A, B, and C. The grades represent the tire's ability to stop on wet pavement as measured under controlled conditions on specified government test surfaces of asphalt and concrete. A tire marked C may have poor traction performance.
- **Temperature:** The temperature grades are A (the highest), B and C, representing the tire's resistance to the generation of heat and its ability to dissipate heat when tested under controlled conditions on a specified indoor laboratory test wheel.

13. **Maximum Permissible Inflation Pressure:** Indicates the tire manufacturers' maximum permissible pressure and/or the pressure at which the maximum load can be carried by the tire. This pressure is normally higher than the manufacturer's recommended cold inflation pressure which can be found on the Safety Compliance Certification Label or Tire Label which is located on the B-Pillar or the edge of the driver's door. The cold inflation pressure should never be set lower than the recommended pressure on the vehicle label.

The tire suppliers may have additional markings, notes or warnings such as standard load, radial tubeless, etc.

Tires, Wheels and Loading

Additional information contained on the tire sidewall for “LT” type tires

“LT” type tires have some additional information beyond those of “P” type tires; these differences are described below.

Note: Tire Quality Grades do not apply to this type of tire.

1. **LT:** Indicates a tire, designated by the Tire and Rim Association (T&RA), that is intended for service on light trucks.

2. Load Range/Load Inflation

Limits: Indicates the tire’s load-carrying capabilities and its inflation limits.

3. **Maximum Load Dual lb. (kg) at psi (kPa) cold:** Indicates the maximum load and tire pressure when the tire is used as a dual; defined as four tires on the rear axle (a total of six or more tires on the vehicle).

4. **Maximum Load Single lb. (kg) at psi (kPa) cold:** Indicates the maximum load and tire pressure when the tire is used as a single; defined as two tires (total) on the rear axle.



Tires, Wheels and Loading

Information on “T” type tires

“T” type tires have some additional information beyond those of “P” type tires; these differences are described below:

T145/80D16 is an example of a tire size.

Note: The temporary tire size for your vehicle may be different from this example. Tire Quality Grades do not apply to this type of tire.

1. **T:** Indicates a type of tire, designated by the Tire and Rim Association (T&RA), that is intended for temporary service on cars, SUVs, minivans and light trucks.

2. **145:** Indicates the nominal width of the tire in millimeters from sidewall edge to sidewall edge. In general, the larger the number, the wider the tire.

3. **80:** Indicates the aspect ratio which gives the tire’s ratio of height to width. Numbers of 70 or lower indicate a short sidewall.

4. **D:** Indicates a “diagonal” type tire.

R: Indicates a “radial” type tire.

5. **16:** Indicates the wheel or rim diameter in inches. If you change your wheel size, you will have to purchase new tires to match the new wheel diameter.

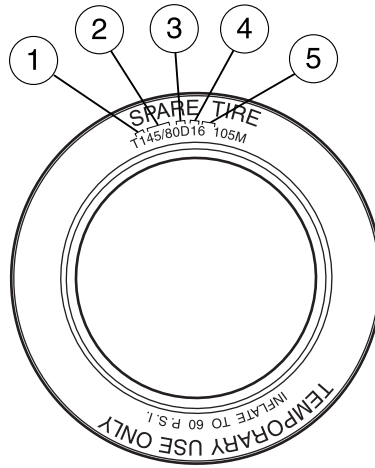

Location of the tire label

You will find a Tire Label containing tire inflation pressure by tire size and other important information located on the B-Pillar or the edge of the driver’s door. Refer to the payload description and graphic in the *Vehicle loading — with and without a trailer* section.

Tires, Wheels and Loading

TIRE PRESSURE MONITORING SYSTEM (TPMS)

Each tire, including the spare (if provided), should be checked monthly when cold and inflated to the inflation pressure recommended by the vehicle manufacturer on the

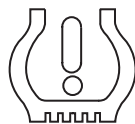

vehicle placard or tire inflation pressure label. (If your vehicle has tires of a different size than the size indicated on the vehicle placard or tire inflation pressure label, you should determine the proper tire inflation pressure for those tires.)

As an added safety feature, your vehicle has been equipped with a tire pressure monitoring system (TPMS) that illuminates a low tire pressure telltale when one or more of your tires is significantly under-inflated. Accordingly, when the low tire pressure telltale illuminates, you should stop and check your tires as soon as possible, and inflate them to the proper pressure. Driving on a significantly under-inflated tire causes the tire to overheat and can lead to tire failure. Under-inflation also reduces fuel efficiency and tire tread life, and may affect the vehicle's handling and stopping ability.

Please note that the TPMS is not a substitute for proper tire maintenance, and it is the driver's responsibility to maintain correct tire pressure, even if under-inflation has not reached the level to trigger illumination of the TPMS low tire pressure telltale.

Your vehicle has also been equipped with a TPMS malfunction indicator to indicate when the system is not operating properly. The TPMS malfunction indicator is combined with the low tire pressure telltale. When the system detects a malfunction, the telltale will flash for approximately one minute and then remain continuously illuminated. This sequence will continue upon subsequent vehicle start-ups as long as the malfunction exists.

When the malfunction indicator is illuminated, the system may not be able to detect or signal low tire pressure as intended. TPMS malfunctions may occur for a variety of reasons, including the installation of replacement or alternate tires or wheels on the vehicle that prevent the TPMS from functioning properly. Always check the TPMS malfunction telltale after replacing one or more tires or wheels on your vehicle to ensure that the replacement or alternate tires and wheels allow the TPMS to continue to function properly.

Tires, Wheels and Loading

The Tire Pressure Monitoring System complies with part 15 of the FCC rules and with RSS-210 of Industry Canada. Operation is subject to the following two conditions: (1) This device may not cause harmful interference, and (2) This device must accept any interference received, including interference that may cause undesired operation.

! **WARNING:** The Tire Pressure Monitoring System is NOT a substitute for manually checking tire pressure. The tire pressure should be checked periodically (at least monthly) using a tire gauge, see *Inflating your tires* in this chapter. Failure to properly maintain your tire pressure could increase the risk of tire failure, loss of control, vehicle rollover and personal injury.

Changing tires with TPMS

Each road tire is equipped with a tire pressure sensor fastened to the inside rim of the wheel. The pressure sensor is covered by the tire and is not visible unless the tire is removed. The pressure sensor is located opposite (180 degrees) from the valve stem. Care must be taken when changing the tire to avoid damaging the sensor. It is recommended that you always have your tires serviced by an authorized dealer.

The tire pressure should be checked periodically (at least monthly) using an accurate tire gauge, refer to *Inflating your tires* in this chapter.

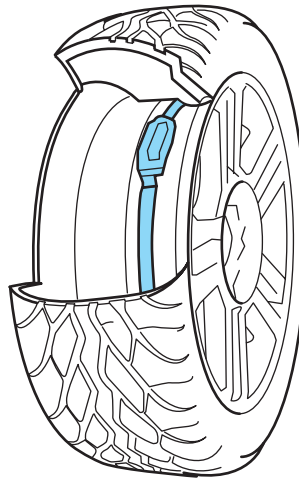

Tires, Wheels and Loading

Understanding your Tire Pressure Monitoring System (TPMS)

The Tire Pressure Monitoring System measures pressure in your four road tires and sends the tire pressure readings to your vehicle. The Low Tire Warning Lamp will turn ON if the tire pressure is significantly low. Once the light is illuminated, your tires are under inflated and need to be inflated to the manufacturer's recommended tire pressure. Even if the light turns ON and a short time later turns OFF, your tire pressure still needs to be checked. Visit www.checkmytires.org for additional information.

When your temporary spare tire is installed

When one of your road tires needs to be replaced with the temporary spare, the TPMS system will continue to identify an issue to remind you that the damaged road wheel/tire needs to be repaired and put back on your vehicle. This includes the optional full-sized matching spare wheel and tire, as it is intended for temporary use only.

To restore the full functionality of the Tire Pressure Monitoring System, have the damaged road wheel/tire repaired and remounted on your vehicle. For additional information, refer to *Changing tires with TPMS* in this section.

Tires, Wheels and Loading

When you believe your system is not operating properly

The main function of the Tire Pressure Monitoring System is to warn you when your tires need air. It can also warn you in the event the system is no longer capable of functioning as intended. Please refer to the following chart for information concerning your Tire Pressure Monitoring System:

Low Tire Pressure Warning Light	Possible cause	Customer Action Required
Solid Warning Light	Tire(s) under-inflated	1. Check your tire pressure to ensure tires are properly inflated; refer to <i>Inflating your tires</i> in this chapter. 2. After inflating your tires to the manufacturer's recommended inflation pressure as shown on the Tire Label (located on the edge of driver's door or the B-Pillar), the vehicle must be driven for at least two minutes over 20 mph (32 km/h) before the light will turn OFF.
	Spare tire in use	Your temporary spare tire is in use. (This includes the optional full-sized matching wheel and tire). Repair the damaged road wheel/tire and reinstall it on the vehicle to restore system functionality. For a description on how the system functions, refer to <i>When your temporary spare tire is installed</i> in this section.
	TPMS malfunction	If your tires are properly inflated and your spare tire is not in use and the light remains ON, have the system inspected by your authorized dealer.

Tires, Wheels and Loading

Low Tire Pressure Warning Light	Possible cause	Customer Action Required
Flashing Warning Light	Spare tire in use	Your temporary spare tire is in use. (This includes the optional full-sized matching wheel and tire). Repair the damaged road wheel and re-mount it on the vehicle to restore system functionality. For a description of how the system functions under these conditions, refer to <i>When your temporary spare tire is installed</i> in this section.
	TPMS malfunction	If your tires are properly inflated and your spare tire is not in use and the TPMS warning light still flashes, have the system inspected by your authorized dealer.

When inflating your tires

When putting air into your tires (such as at a gas station or in your garage), the Tire Pressure Monitoring System may not respond immediately to the air added to your tires.

It may take up to two minutes of driving over 20 mph (32 km/h) for the light to turn OFF after you have filled your tires to the recommended inflation pressure.

How temperature affects your tire pressure

The Tire Pressure Monitoring System (TPMS) monitors tire pressure in each pneumatic tire. While driving in a normal manner, a typical passenger tire inflation pressure may increase approximately 2 to 4 psi (14 to 28 kPa) from a cold start situation. If the vehicle is stationary over night with the outside temperature significantly lower than the daytime temperature, the tire pressure may decrease approximately 3 psi (20.7 kPa) for a drop of 30° F (16.6°C) in ambient temperature. This lower pressure value may be detected by the TPMS as being significantly lower than the recommended inflation pressure and activate the TPMS warning for low tire pressure. If the low tire pressure warning light is ON, visually check each tire to verify that no tire is flat. (If one or more tires are flat, repair as necessary.) Check air pressure in the road tires. If any tire is under-inflated, carefully drive the vehicle to the nearest location where air can be added to the tires. Inflate all the tires to the recommended inflation pressure.

Tires, Wheels and Loading

SNOW TIRES AND CHAINS



WARNING: Snow tires must be the same size, load index, speed rating as those originally provided by Ford. Use of any tire or wheel not recommended by Ford can affect the safety and performance of your vehicle, which could result in an increased risk of loss of vehicle control, vehicle rollover, personal injury and death. Additionally, the use of non-recommended tires and wheels could cause steering, suspension, axle or transfer case/power transfer unit failure.

The tires on your vehicle have all weather treads to provide traction in rain and snow. However, in some climates, you may need to use snow tires and chains. If you need to use chains, it is recommended that steel wheels (of the same size and specifications) be used, as chains may chip aluminum wheels.

Follow these guidelines when using snow tires and chains:

- Use only cable type chains offered by Ford Motor Company as an accessory or equivalent. Using SAE class S or other conventional link type chains may cause damage to the vehicle's wheel house and/or body.
- Install chains securely, verifying that the chains do not touch any wiring, brake lines or fuel lines.
- Drive cautiously. If you hear the chains rub or bang against your vehicle, stop and re-tighten the chains. If this does not work, remove the chains to prevent damage to your vehicle.
- If possible, avoid fully loading your vehicle.
- Remove the tire chains when they are no longer needed. Do not use tire chains on dry roads.
- The suspension insulation and bumpers will help prevent vehicle damage. Do not remove these components from your vehicle when using snow tires and chains.
- Do not exceed 30 mph (48 km/h) with tire cables on your vehicle.

VEHICLE LOADING – WITH AND WITHOUT A TRAILER

This section will guide you in the proper loading of your vehicle and/or trailer, to keep your loaded vehicle weight within its design rating capability, with or without a trailer. Properly loading your vehicle will provide maximum return of vehicle design performance. Before loading

Tires, Wheels and Loading

your vehicle, familiarize yourself with the following terms for determining your vehicle's weight ratings, with or without a trailer, from the vehicle's Tire Label or Safety Compliance Certification Label:

Base Curb Weight – is the weight of the vehicle including a full tank of fuel and all standard equipment. It does not include passengers, cargo, or optional equipment.

Vehicle Curb Weight – is the weight of your new vehicle when you picked it up from your authorized dealer plus any aftermarket equipment.

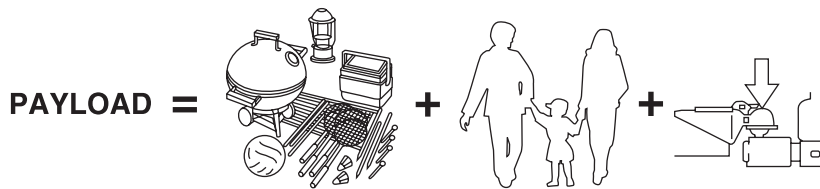

Payload – is the combined weight of cargo and passengers that the vehicle is carrying. The maximum payload for your vehicle can be found on the Tire Label on the B-Pillar or the edge of the driver's door (vehicles exported outside the US and Canada may not have a Tire Label). Look for **“THE COMBINED WEIGHT OF OCCUPANTS AND CARGO SHOULD NEVER EXCEED XXX kg OR XXX lb.”** for maximum payload. The payload listed on the Tire Label is the maximum payload for the vehicle as built by the assembly plant. If any aftermarket or authorized-dealer installed equipment has been installed on the vehicle, the weight of the equipment must be subtracted from the payload listed on the Tire Label in order to determine the new payload.

⚠ WARNING: The appropriate loading capacity of your vehicle can be limited either by volume capacity (how much space is available) or by payload capacity (how much weight the vehicle should carry). Once you have reached the maximum payload of your vehicle, do not add more cargo, even if there is space available. Overloading or improperly loading your vehicle can contribute to loss of vehicle control and vehicle rollover.

Tires, Wheels and Loading

Example only:

TIRE AND LOADING INFORMATION			
SEATING CAPACITY		TOTAL 5	FRONT 2 REAR 3
The combined weight of occupants and cargo should never exceed: XXX kg or XXX lbs.			
TIRE	SIZE	COLD TIRE PRESSURE	SEE OWNERS MANUAL FOR ADDITIONAL INFORMATION
FRONT	LT225/75R 16.5E	200 KPA, 29 PSI	
REAR	LT225/75R 16.5E	200 KPA, 29 PSI	
SPARE	T145/80D16 P225/60R17	420 KPA, 60 PSI 200 KPA, 29 PSI	

TIRE AND LOAD INFORMATION			
SEATING CAPACITY / NOMBRE DE PLACES		TOTAL / TOTAL XX	FRONT / AVANT XX REAR / ARRIERE X
The combined weight of occupants and cargo should never exceed: XXX kg. La charge du véhicule (occupants et bagages) ne doit jamais dépasser: XXX lbs.			
TIRE / PNEUS	SIZE / DIMENSIONS	COLD TIRE PRESSURE / PRESSION A FROID	SEE OWNERS MANUAL FOR ADDITIONAL INFORMATION CONSULTEZ LE GUIDE DU PROPRIETAIRE POUR DE PLUS AMPLES RENSEIGNEMENTS
FRONT / AVANT	LT225/75R 16.5E	200 KPA, 29 PSI	
REAR / ARRIERE	LT225/75R 16.5E	200 KPA, 29 PSI	
SPARE / PNEU DE SECOURS	T145/80D16 P225/60R17	420 KPA, 60 PSI 200 KPA, 29 PSI	

CARGO

=



+

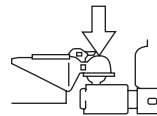

Cargo Weight – includes all weight added to the Base Curb Weight, including cargo and optional equipment. When towing, trailer tongue load weight is also part of cargo weight.

GAW (Gross Axle Weight) – is the total weight placed on each axle (front and rear) – including vehicle curb weight and all payload.

Tires, Wheels and Loading

GAWR (Gross Axle Weight Rating) – is the maximum allowable weight that can be carried by a single axle (front or rear). **These numbers are shown on the Safety Compliance Certification Label located on the B-Pillar or the edge of the driver's door. The total load on each axle must never exceed its GAWR.**

Note: For trailer towing information refer to *Trailer towing* found in this chapter or the *RV and Trailer Towing Guide* provided by your authorized dealer.

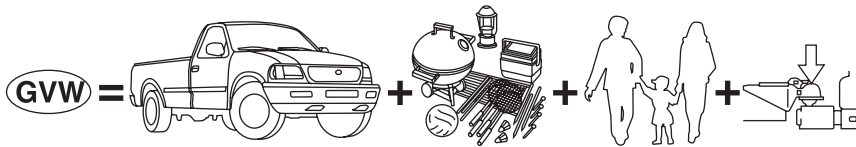

GVW (Gross Vehicle Weight) – is the Vehicle Curb Weight + cargo + passengers.

GVWR (Gross Vehicle Weight Rating) – is the maximum allowable weight of the fully loaded vehicle (including all options, equipment, passengers and cargo). **The GVWR is shown on the Safety Compliance Certification Label located on the B-Pillar or the edge of the driver's door. The GVW must never exceed the GVWR.**

MFD. BY FORD MOTOR CO.					
DATE: XX/XX	GVWR: XXXXLB / XXXXKG				
FRONT GAWR: XXXXL	REAR GAWR: XXXXLB				
XXXXKG	WITH	XXXXKG	WITH		
XXXX/XXXXXXX	TIRES	XXXX/XXXXXXX	TIRES		
XXXX.XX	RIMS	XXXX.XX	RIMS		
AT XXX kPa/XX	PSI COLD	AT XXX kPa/XX	PSI COLD		
THIS VEHICLE CONFORMS TO ALL APPLICABLE FEDERAL MOTOR VEHICLE SAFETY AND THEFT PREVENTION STANDARDS IN EFFECT ON THE DATE OF MANUFACTURE SHOWN ABOVE.					
VIN: XXXXXXXXXXXXXXXXX			XXXXXX		
TYPE: XXX			XXXXXX		
EXT PNT: XX	RC: XX	DSO:			
WB ¹ BRK ²	INT TR ³	TP/PS ⁴	R ⁵	AXLE ⁶	TR SPR ⁷
XXX X	XX	X	XX	X XX	XXX
XXXXXXXXXXXX XXX XXXX-XXXXXX-XX					

Tires, Wheels and Loading

 **WARNING:** Exceeding the Safety Compliance Certification Label vehicle weight rating limits could result in substandard vehicle handling or performance, engine, transmission and/or structural damage, serious damage to the vehicle, loss of control and personal injury.

$$\text{GCW} = \text{GVW} + \text{Trailer}$$

GCW (Gross Combined Weight) – is the weight of the loaded vehicle (GVW) plus the weight of the fully loaded trailer.

GCWR (Gross Combined Weight Rating) – is the maximum allowable weight of the vehicle and the loaded trailer – including all cargo and passengers – that the vehicle can handle without risking damage. (Important: The towing vehicles' braking system is rated for operation at GVWR, not at GCWR. Separate functional brakes should be used for safe control of towed vehicles and for trailers where the GCW of the towing vehicle plus the trailer exceed the GVWR of the towing vehicle. **The GCW must never exceed the GCWR.**

Maximum Loaded Trailer Weight – is the highest possible weight of a fully loaded trailer the vehicle can tow. It assumes a vehicle with only mandatory options, no cargo (internal or external), a tongue load of 10–15% (conventional trailer), and driver only (150 lb. [68 kg]). **Consult your authorized dealer (or the *RV and Trailer Towing Guide* provided by your authorized dealer) for more detailed information.**

 **WARNING:** Do not exceed the GVWR or the GAWR specified on the Safety Compliance Certification Label.

 **WARNING:** Do not use replacement tires with lower load carrying capacities than the original tires because they may lower the vehicle's GVWR and GAWR limitations. Replacement tires with a higher limit than the original tires do not increase the GVWR and GAWR limitations.

Tires, Wheels and Loading



WARNING: Exceeding any vehicle weight rating limitation could result in serious damage to the vehicle and/or personal injury.

Steps for determining the correct load limit:

1. Locate the statement “The combined weight of occupants and cargo should never exceed XXX kg or XXX lbs.” on your vehicle’s placard.
2. Determine the combined weight of the driver and passengers that will be riding in your vehicle.
3. Subtract the combined weight of the driver and passengers from XXX kg or XXX lbs.
4. The resulting figure equals the available amount of cargo and luggage load capacity. For example, if the “XXX” amount equals 1,400 lbs. and there will be five 150 lb. passengers in your vehicle, the amount of available cargo and luggage load capacity is 650 lbs. ($1400 - 750$ (5×150) = 650 lb.). In metric units ($635 - 340$ (5×68) = 295 kg.)
5. Determine the combined weight of luggage and cargo being loaded on the vehicle. That weight may not safely exceed the available cargo and luggage load capacity calculated in Step 4.
6. If your vehicle will be towing a trailer, load from your trailer will be transferred to your vehicle. Consult this manual to determine how this reduces the available cargo and luggage load capacity of your vehicle.

The following gives you a few examples on how to calculate the available amount of cargo and luggage load capacity:

- Another example for your vehicle with 1,400 lb. (635 kg) of cargo and luggage capacity. You decide to go golfing. Is there enough load capacity to carry you, 4 of your friends and all the golf bags? You and four friends average 220 lb. (99 kg) each and the golf bags weigh approximately 30 lb. (13.5 kg) each. The calculation would be: $1,400 - (5 \times 220) - (5 \times 30) = 1,400 - 1,100 - 150 = 150$ lb. Yes, you have enough load capacity in your vehicle to transport four friends and your golf bags. In metric units, the calculation would be: $635 \text{ kg} - (5 \times 99 \text{ kg}) - (5 \times 13.5 \text{ kg}) = 635 - 495 - 67.5 = 72.5$ kg.
- A final example for your vehicle with 1,400 lb. (635 kg) of cargo and luggage capacity. You and one of your friends decide to pick up cement from the local home improvement store to finish that patio you have been planning for the past 2 years. Measuring the inside of the vehicle with the rear seat folded down, you have room for 12-100 lb. (45 kg) bags of cement. Do you have enough load capacity

Tires, Wheels and Loading

to transport the cement to your home? If you and your friend each weigh 220 lb. (99 kg), the calculation would be: $1,400 - (2 \times 220) - (12 \times 100) = 1,400 - 440 - 1,200 = -240$ lb. No, you do not have enough cargo capacity to carry that much weight. In metric units, the calculation would be: $635 \text{ kg} - (2 \times 99 \text{ kg}) - (12 \times 45 \text{ kg}) = 635 - 198 - 540 = -103$ kg. You will need to reduce the load weight by at least 240 lb. (104 kg). If you remove 3-100 lb. (45 kg) cement bags, then the load calculation would be:

$1,400 - (2 \times 220) - (9 \times 100) = 1,400 - 440 - 900 = 60$ lb. Now you have the load capacity to transport the cement and your friend home. In metric units, the calculation would be: $635 \text{ kg} - (2 \times 99 \text{ kg}) - (9 \times 45 \text{ kg}) = 635 - 198 - 405 = 32$ kg.

The above calculations also assume that the loads are positioned in your vehicle in a manner that does not overload the Front or the Rear Gross Axle Weight Rating specified for your vehicle on the Safety Compliance Certification Label found on the edge of the driver's door.

TRAILER TOWING

Note: Long wheel based vehicles are NOT rated for towing.

Your vehicle is classified as a light duty towing vehicle. Do not tow a trailer until your vehicle has been driven at least 1,000 miles (1,600 km).

Towing a trailer places an additional load on your vehicle's engine, transmission, brakes, tires and suspension. Inspect these components carefully after towing.

Your loaded trailer should weigh no more than 1,500 lb. (680 kg). **Do not exceed the GVWR specified on the Safety Compliance Certification Label.**



WARNING: Towing trailers beyond the maximum recommended gross trailer weight exceeds the limit of the vehicle and could result in engine damage, transmission damage, structural damage, loss of vehicle control, vehicle rollover and personal injury.

The GCW of your vehicle and trailer should not exceed 6,600 lb. (2,993 kg).

Preparing to tow

Use the proper equipment for towing a trailer and make sure it is properly attached to your vehicle. Contact your authorized dealer or a reliable trailer dealer as soon as possible if you require assistance.

Tires, Wheels and Loading

Hitches

Do not use hitches that clamp onto the vehicle bumper. Use a load carrying hitch. You must distribute the load in your trailer so that 10–15% of the total weight of the trailer is on the tongue.

Safety chains

Always connect the trailer's safety chains to the frame or hook retainers of the vehicle hitch. To connect the trailer's safety chains, cross the chains under the trailer tongue and allow slack for turning corners.

If you use a rental trailer, follow the instructions that the rental agency gives to you.

Do not attach safety chains to the bumper.

Trailer brakes

Electric brakes and manual, automatic or surge-type trailer brakes are safe if installed properly and adjusted to the manufacturer's specifications. The trailer brakes must meet local and Federal regulations.



WARNING: Do not connect a trailer's hydraulic brake system directly to your vehicle's brake system. Your vehicle may not have enough braking power and your chances of having a collision greatly increase.

The braking system of the tow vehicle is rated for operation at the GVWR not GCWR.

Trailer lamps

Trailer lamps are required on most towed vehicles. Make sure all running lights, brake lights, turn signals and hazard lights are working. Contact your authorized dealer or trailer rental agency for proper instructions and equipment for hooking up trailer lamps.

Driving while you tow

When towing a trailer:

- To ensure proper “break-in” of powertrain components, do not trailer tow during the first 1,000 miles (1,600 km) of a new vehicle.
- To ensure proper “break-in” of powertrain components during the first 500 miles (800 km) of trailer towing, drive no faster than 70 mph (113 km/h) with no full throttle starts.

Tires, Wheels and Loading

- Turn off the speed control. The speed control may shut off automatically when you are towing on long, steep grades.
- Consult your local motor vehicle speed regulations for towing a trailer.
- To eliminate excessive shifting, use a lower gear. This will also assist in transmission cooling. For additional information, refer to *Automatic transmission operation* in the *Driving* chapter.
- Anticipate stops and brake gradually.
- Do not exceed the GCWR rating or transmission damage may occur.

Servicing after towing

If you tow a trailer for long distances, your vehicle will require more frequent service intervals. Refer to your *scheduled maintenance information* for more information.

Trailer towing tips

- Practice turning, stopping and backing up before starting on a trip to get the feel of the vehicle trailer combination. When turning, make wider turns so the trailer wheels will clear curbs and other obstacles.
- Allow more distance for stopping with a trailer attached.
- If you are driving down a long or steep hill, shift to a lower gear. Do not apply the brakes continuously, as they may overheat and become less effective.
- The trailer tongue weight should be 10–15% of the loaded trailer weight.
- If you will be towing a trailer frequently in hot weather, hilly conditions, at GCWR, or any combination of these factors, consider refilling your rear axle with synthetic gear lube if not already so equipped. Refer to the *Maintenance and Specifications* chapter for the lubricant specification. Remember that regardless of the rear axle lube used, do not tow a trailer for the first 1,000 miles (1,600 km) of a new vehicle, and that the first 500 miles (800 km) of towing be done at no faster than 70 mph (113 km/h) with no full throttle starts.
- After you have traveled 50 miles (80 km), thoroughly check your hitch, electrical connections and trailer wheel lug nuts.
- To aid in engine/transmission cooling and A/C efficiency during hot weather while stopped in traffic, place the gearshift lever in P (Park).
- Vehicles with trailers should not be parked on a grade. If you must park on a grade, place wheel chocks under the trailer's wheels.

Tires, Wheels and Loading

Launching or retrieving a boat

Disconnect the wiring to the trailer before backing the trailer into the water. Reconnect the wiring to the trailer after the trailer is removed from the water.

When backing down a ramp during boat launching or retrieval:

- do not allow the static water level to rise above the bottom edge of the rear bumper.
- do not allow waves to break higher than 6 inches (15 cm) above the bottom edge of the rear bumper.

Exceeding these limits may allow water to enter vehicle components:

- causing internal damage to the components.
- affecting driveability, emissions and reliability.

Replace the rear axle lubricant any time the axle has been submerged in water. Rear axle lubricant quantities are not to be checked or changed unless a leak is suspected or repair required.

RECREATIONAL TOWING

Follow these guidelines if you have a need for recreational (RV) towing. An example of recreational towing would be towing your vehicle behind a motorhome. These guidelines are designed to ensure that your transmission is not damaged.

All vehicles: Do not tow your vehicle with any wheels on the ground, as vehicle or transmission damage may occur. It is recommended to tow your vehicle with all four (4) wheels off the ground such as when using a car-hauling trailer. Otherwise, no recreational towing is permitted.

In case of a roadside emergency with a disabled vehicle, see *Wrecker towing* in the *Roadside Emergencies* chapter.

Driving

STARTING

Positions of the ignition

1. Off— shuts off the engine and all accessories/locks the gearshift lever and allows key removal.
2. Accessory— allows the electrical accessories such as the radio to operate while the engine is not running.
3. On— all electrical circuits operational. Warning lights illuminated. Key position when driving.
4. Start— cranks the engine. Release the key as soon as the engine starts.

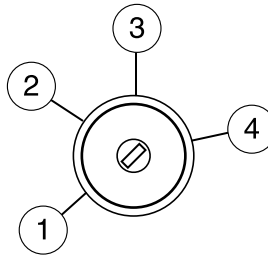

Preparing to start your vehicle

Engine starting is controlled by the powertrain control system. This system meets all Canadian interference-causing equipment standard requirements regulating the impulse electrical field strength of radio noise.

When starting a fuel-injected engine, avoid pressing the accelerator before or during starting. Only use the accelerator when you have difficulty starting the engine. For more information on starting the vehicle, refer to *Starting the engine* in this chapter.



WARNING: Extended idling at high engine speeds can produce very high temperatures in the engine and exhaust system, creating the risk of fire or other damage.



WARNING: Do not park, idle, or drive your vehicle in dry grass or other dry ground cover. The emission system heats up the engine compartment and exhaust system, which can start a fire.



WARNING: Do not start your vehicle in a closed garage or in other enclosed areas. Exhaust fumes can be toxic. Always open the garage door before you start the engine. See *Guarding against exhaust fumes* in this chapter for more instructions.

Driving

 **WARNING:** If you smell exhaust fumes inside your vehicle, have your dealer inspect your vehicle immediately. Do not drive if you smell exhaust fumes.

Important safety precautions

A computer system controls the engine's idle revolutions per minute (RPM). When the engine starts, the idle RPM runs higher than normal in order to warm the engine. If the engine idle speed does not slow down automatically, have the vehicle checked. Do not allow the vehicle to idle for more than 10 minutes at the higher engine RPM.

Before starting the vehicle:

1. Make sure all vehicle occupants have buckled their safety belts. For more information on safety belts and their proper usage, refer to the *Seating and Safety Restraints* chapter.
2. Make sure the headlamps and vehicle accessories are off.
3. Make sure the gearshift is in P (Park).
4. Make sure the parking brake is set.

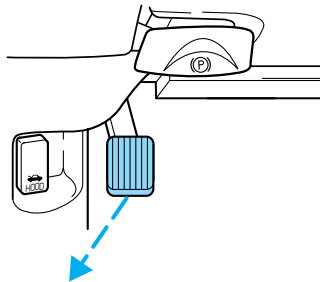

Driving

5. Turn the key to 3 (on) without turning the key to 4 (start).

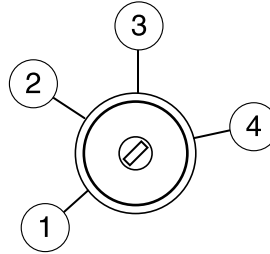

Some warning lights will briefly illuminate. See *Warning lights and chimes* in the *Instrument Cluster* chapter for more information regarding the warning lights.

Starting the engine

1. Turn the key to 3 (on) without turning the key to 4 (start).
2. Turn the key to 4 (start), then release the key as soon as the engine starts. Excessive cranking could damage the starter.

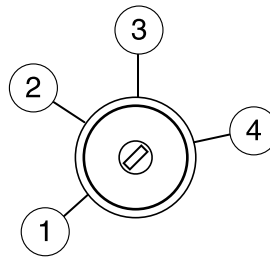

Note: If the engine does not start within five seconds on the first try, turn the key to OFF, wait 10 seconds and try again. If the engine still fails to start, press the accelerator to the floor and try again; this will allow the engine to crank with the fuel shut off in case the engine is flooded with fuel.

Cold weather starting (flexible fuel vehicles only)

The starting characteristics of all grades of E₈₅ ethanol make it unsuitable for use when ambient temperatures fall below 0°F (-18°C). Consult your fuel distributor for the availability of winter grade ethanol. As the outside temperature approaches freezing, ethanol fuel distributors should supply winter grade ethanol (same as with unleaded gasoline). If summer grade ethanol is used in cold weather conditions, 0°F to 32°F (-18°C to 0°C), you may experience increased cranking times, rough idle or hesitation until the engine has warmed up.

Driving

You may experience a decrease in peak performance when the engine is cold when operating on E₈₅ ethanol.

Do not crank the engine for more than 10 seconds at a time as starter damage may occur. If the engine fails to start, turn the key to off and wait 30 seconds before trying again.

Do not use starting fluid such as ether in the air intake system. Such fluid could cause immediate explosive damage to the engine and possible personal injury.

If you should experience cold weather starting problems on E₈₅ ethanol, and neither an alternative brand of E₈₅ ethanol nor an engine block heater is available, the addition of unleaded gasoline to your tank will improve cold starting performance. Your vehicle is designed to operate on E₈₅ ethanol alone, unleaded gasoline alone, or any mixture of the two.

See *Choosing the right fuel* in the *Maintenance and Specifications* chapter for more information on ethanol.

If the engine fails to start using the preceding instructions (flexible fuel vehicles only)

1. Press and hold down the accelerator 1/3 to 1/2 way to floor, then crank the engine.
2. When the engine starts, release the key, then gradually release the accelerator pedal as the engine speeds up. If the engine still fails to start, repeat Step 1.

Guarding against exhaust fumes

Carbon monoxide is present in exhaust fumes. Take precautions to avoid its dangerous effects.



WARNING: If you smell exhaust fumes inside your vehicle, have your dealer inspect your vehicle immediately. Do not drive if you smell exhaust fumes.

Important ventilating information

If the engine is idling while the vehicle is stopped for a long period of time, open the windows at least one inch (2.5 cm) or adjust the heating or air conditioning to bring in fresh air.

Driving

ENGINE BLOCK HEATER (IF EQUIPPED)

An engine block heater warms the engine coolant which aids in starting and allows the heater/defroster system to respond quickly. If your vehicle is equipped with this system, your equipment includes a heater element which is installed in your engine block and a wire harness which allows the user to connect the system to a grounded 120 volt a/c electrical source. The block heater system is most effective when outdoor temperatures reach below 0°F (-18°C).

For flexible fuel vehicles, if operating with E₈₅ ethanol, an engine block heater must be used if ambient temperature is below 0°F (-18°C).

See *Cold weather starting* in the *Driving* chapter for more information on starting with ethanol.



WARNING: Failure to follow engine block heater instructions could result in property damage or physical injury.



WARNING: To reduce the risk of electrical shock, do not use your heater with ungrounded electrical systems or two-pronged (cheater) adapters.

Prior to using the engine block heater, follow these recommendations for proper and safe operation:

- For your safety, use an outdoor extension cord that is product certified by Underwriter's Laboratory (UL) or Canadian Standards Association (CSA). Use only an extension cord that can be used outdoors, in cold temperatures, and is clearly marked "Suitable for Use with Outdoor Appliances." Never use an indoor extension cord outdoors; it could result in an electric shock or fire hazard.
- Use a 16 gauge outdoor extension cord, minimum.
- Use as short an extension cord as possible.
- Do not use multiple extension cords. Instead, use one extension cord which is long enough to reach from the engine block heater cord to the outlet without stretching.
- Make certain that the extension cord is in excellent condition (not patched or spliced). Store your extension cord indoors at temperatures above 32°F (0°C). Outdoor conditions can deteriorate extension cords over a period of time.

- To reduce the risk of electrical shock, do not use your heater with ungrounded electrical systems or two pronged (cheater) adapters. Also ensure that the block heater, especially the cord, is in good condition before use.
- Make sure that when in operation, the extension cord plug /engine block heater cord plug connection is free and clear of water in order to prevent possible shock or fire.
- Be sure that areas where the vehicle is parked are clean and clear of all combustibles such as petroleum products, dust, rags, paper and similar items.
- Be sure that the engine block heater, heater cord and extension cord are solidly connected. A poor connection can cause the cord to become very hot and may result in an electrical shock or fire. Be sure to check for heat anywhere in the electrical hookup once the system has been operating for approximately a half hour.
- Finally, have the engine block heater system checked during your fall tune-up to be sure it's in good working order.

How to use the engine block heater

Ensure the receptacle terminals are clean and dry prior to use. To clean them, use a dry cloth.

Depending on the type of factory installed equipment, your engine block heater system may consume anywhere between 400 watts or 1000 watts of power per hour. Your factory installed block heater system does not have a thermostat; however, maximum temperature is attained after approximately three hours of operation. Block heater operation longer than 3 hours will not improve system performance and will unnecessarily use additional electricity.

Make sure system is unplugged and properly stowed before driving the vehicle. While not in use, make sure the protective cover seals the prongs of the engine block heater cord plug.

BRAKES

Your service brakes are self-adjusting. Refer to the *scheduled maintenance information* for scheduled maintenance.

Driving

Occasional brake noise is normal and often does not indicate a performance concern with the vehicle's brake system. In normal operation, automotive brake systems may emit occasional or intermittent squeal or groan noises when the brakes are applied. Such noises are usually heard during the first few brake applications in the morning; however, they may be heard at any time while braking and can be aggravated by environmental conditions such as cold, heat, moisture, road dust, salt or mud. If a "metal-to-metal," "continuous grinding" or "continuous squeal" sound is present while braking, the brake linings may be worn-out and should be inspected by an authorized dealer.

Refer to *Brake system warning light* in the *Instrument Cluster* chapter for information on the brake system warning light.



WARNING: If you are driving down a long or steep hill, shift to a lower gear. Do not apply your brakes continuously, as they may overheat and become less effective.

Under normal operating conditions, brake dust may accumulate on the wheels. Some brake dust is inevitable as brakes wear and does not contribute to brake noise. The use of modern friction materials with emphasis on improved performance and environmental considerations can lead to more dust than in the past. Brake dust can be cleaned by weekly washing with soapy water and a soft sponge. Heavier deposits can be removed with Motorcraft Wheel and Tire Cleaner (ZC-37-A).

Anti-lock brake system (ABS)

This vehicle is equipped with an anti-lock braking system (ABS). A noise from the hydraulic pump motor and pulsation in the pedal may be observed during ABS braking events. Pedal pulsation coupled with noise while braking under panic conditions or on loose gravel, bumps, wet or snowy roads is normal and indicates proper functioning of the vehicle's anti-lock brake system. If the vehicle has continuous vibration or shudder in the steering wheel while braking, the vehicle should be inspected by an authorized dealer.

The ABS operates by detecting the onset of wheel lockup during brake applications and compensates for this tendency. The wheels are prevented from locking even when the brakes are firmly applied. The accompanying illustration depicts the advantage of an ABS equipped vehicle (on bottom) to a non-ABS equipped vehicle (on top) during hard braking with loss of front braking traction.

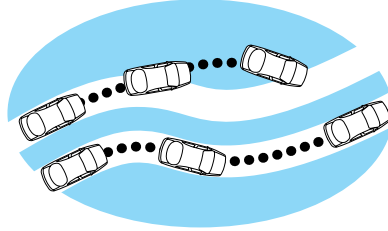

Using ABS

- In an emergency or when maximum efficiency from the four-wheel ABS is required, apply continuous force on the brake. The four wheel ABS will be activated immediately, thus allowing you to retain steering control of your vehicle and, providing there is sufficient space, will enable you to avoid obstacles and bring the vehicle to a controlled stop.
- The anti-lock system does not reduce stopping distance. Always leave enough room between your vehicle and the vehicle in front of you to stop.
- We recommend that you familiarize yourself with this braking technique. However, avoid taking any unnecessary risks.

ABS warning lamp

The ABS warning lamp in the instrument cluster momentarily illuminates when the ignition is turned on. If the light does not illuminate momentarily at start up, remains on or continues to flash, the ABS needs to be serviced.



With the ABS light on, the anti-lock brake system is disabled and normal braking is still effective unless the brake warning light also remains illuminated with parking brake released. If your brake warning lamp illuminates, have your vehicle serviced immediately.



Driving

Parking brake

Apply the parking brake whenever the vehicle is parked.

To set the parking brake:

1. Move the gearshift to P (Park).
2. Push pedal downward.

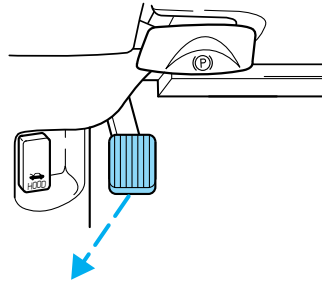

The BRAKE warning lamp in the instrument cluster illuminates and remains illuminated (when the ignition is turned on) until the parking brake is fully released.



WARNING: Always set the parking brake fully and make sure the gearshift is latched in P (Park). Turn the ignition to the off position and remove the key whenever you leave your vehicle.

The parking brake is not recommended to stop a moving vehicle. However, if the normal brakes fail, the parking brake can be used to stop your vehicle in an emergency. Since the parking brake applies only the rear brakes, the vehicle's stopping distance will increase greatly and the handling of your vehicle will be adversely affected.

Pull the lever to release the parking brake.

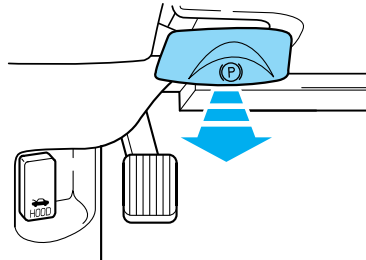

TRACTION CONTROL™ (IF EQUIPPED)

The Traction Control™ system helps you maintain the stability and steerability of your vehicle, especially on slippery road surfaces such as snow- or ice-covered roads and gravel roads. The system will allow your vehicle to make better use of available traction in these conditions.

During Traction Control™ operation, the traction control active light will illuminate, you may hear an electric motor type of sound coming from the engine compartment, and the engine may not “rev-up” when you push further on the accelerator. This is normal system behavior and should be no reason for concern.



 **WARNING:** Aggressive driving in any road conditions can cause you to lose control of your vehicle increasing the risk of severe personal injury or property damage. The occurrence of a Traction Control™ event is an indication that at least some of the tires have exceeded their ability to grip the road; this may lead to an increased risk of loss of vehicle control, vehicle rollover, personal injury and death. If you experience a severe road event, SLOW DOWN.

The Traction Control™ switch is located on the instrument panel. The Traction Control™ system will automatically turn on every time the ignition is turned off and on. The Traction Control™ system should normally be left on.

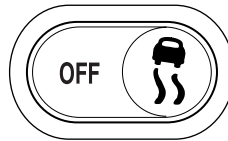

If you should become stuck in snow or ice or on a very slippery road surface, try switching the Traction Control™ system off by pressing the switch on the instrument panel. Switching the Traction Control™ system off may allow excess wheel spin to “dig” the vehicle out and enable a successful “rocking” maneuver.

When the Traction Control™ system is off, an indicator light will illuminate and will remain on until the system is turned back on or the ignition is turned off and on. Remember to switch the Traction Control™ system back on once the vehicle is no longer stuck.

If a system fault is detected, the traction control active light will illuminate, the Traction Control™ button will not turn the system on or off and your vehicle should be serviced by an authorized dealer.

Driving

STEERING

To help prevent damage to the power steering system, never hold the steering wheel at its furthest turning points (until it stops) for more than a few seconds when the engine is running.

It is also important to maintain a proper power steering fluid level in the power steering fluid reservoir:

- Do not operate the vehicle with a low power steering pump fluid level. See *Power steering fluid* in the *Maintenance and Specifications* chapter.
- Some noise is normal during operation. If the noise is excessive, check for low power steering pump fluid level before seeking service by your authorized dealer.
- Heavy or uneven steering efforts may be caused by low power steering pump fluid level. Check for low power steering pump fluid level before seeking service by your authorized dealer.
- Do not fill the power steering pump reservoir above the maximum level, as this may result in leaks from the reservoir. See *Power steering fluid* in the *Maintenance and Specifications* chapter.

If the power steering system breaks down (or if the engine is off), you can steer the vehicle manually, but it takes more effort.

If the steering wanders or pulls, check for:

- an improperly inflated tire
- uneven tire wear
- loose or worn suspension components
- loose or worn steering components
- improper steering alignment

AIR SUSPENSION SYSTEM (IF EQUIPPED)

The air suspension system is designed to improve ride, handling and general vehicle performance during:

- Certain road conditions
- Steering maneuvers
- Braking
- Accelerations

This system keeps the rear of your vehicle at a constant level by automatically adding air or releasing air from the springs.

If you exceed the load limit, the rear air suspension may not operate.

The air suspension shut-off switch is located on the left side of the trunk. If this switch is in the off position, the rear air suspension will not operate.



WARNING: On vehicles equipped with air suspension, turn off the air suspension switch prior to jacking, hoisting or towing your vehicle.



Normal vehicle operation does not require any action by the driver.

TRACTION-LOK™ AXLE (IF EQUIPPED)

This axle provides added traction on slippery surfaces, particularly when one wheel is on a poor traction surface. Under normal conditions, the Traction-Lok™ axle functions like a standard rear axle.

Extended use of other than the manufacturer's specified size tires on a Traction-Lok™ rear axle could result in a permanent reduction in effectiveness. This loss of effectiveness does not affect normal driving and should not be noticeable to the driver.

AUTOMATIC TRANSMISSION OPERATION

Brake-shift interlock

This vehicle is equipped with a brake-shift interlock feature that prevents the gearshift lever from being moved from P (Park) when the ignition is in the on position unless brake pedal is depressed.

If you cannot move the gearshift lever out of P (Park) with ignition in the on position and the brake pedal depressed, it is possible that a fuse has blown or the vehicle's brakelamps are not operating properly. Refer to *Fuses and relays* in the *Roadside Emergencies* chapter.

If the fuse is not blown, perform the following procedure:

1. Apply the parking brake, turn the ignition to 2 (Accessory).

Driving

2. Locate the access plug on the underside of the steering column cover.

3. Remove the access plug using a flat head screwdriver. Insert the screwdriver into the access hole nearest the steering wheel. Then push and hold the override button using a flat head screwdriver. Apply the brake pedal and shift the transmission into N (Neutral) while continuing to depress the override button.

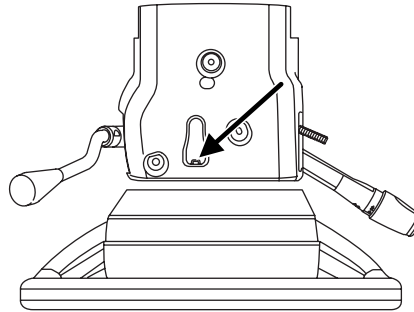

4. Reinstall the access plug cover, start the vehicle and release the parking brake.



WARNING: Do not drive your vehicle until you verify that the brakelamps are working.



WARNING: Always set the parking brake fully and make sure the gearshift is latched in P (Park). Turn the ignition to the off position and remove the key whenever you leave your vehicle.



WARNING: If the parking brake is fully released, but the brake warning lamp remains illuminated, the brakes may not be working properly. See your authorized dealer.

Understanding the gearshift positions of the 4-speed automatic transmission



P (Park)

This position locks the transmission and prevents the rear wheels from turning.

To put your vehicle in gear:

- Start the engine
- Depress the brake pedal
- Move the gearshift lever into the desired gear

To put your vehicle in P (Park):

- Come to a complete stop
- Move the gearshift lever and securely latch it in P (Park)



WARNING: Always set the parking brake fully and make sure the gearshift is latched in P (Park). Turn the ignition to the off position and remove the key whenever you leave your vehicle.

R (Reverse)

With the gearshift lever in R (Reverse), the vehicle will move backward. Always come to a complete stop before shifting into and out of R (Reverse).

N (Neutral)

With the gearshift lever in N (Neutral), the vehicle can be started and is free to roll. Hold the brake pedal down while in this position.

D (Overdrive)

The normal driving position for the best fuel economy. Transmission operates in gears one through four.



Overdrive can be deactivated by pressing the transmission control switch on the gearshift lever.

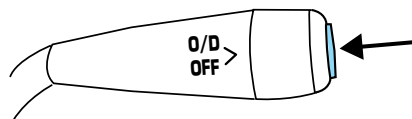

The transmission control indicator light (TCIL) will illuminate on the instrument cluster.

O/D
OFF

Drive (not shown)

Drive is activated when the transmission control switch is pressed.

- This position allows for all forward gears except overdrive.

Driving

- O/D OFF lamp is illuminated.
- Provides engine braking.
- Use when driving conditions cause excessive shifting from O/D to other gears. Examples: heavy city traffic where continuous shifting in and out of overdrive occurs, hilly terrain, heavy loads, trailer towing and when engine braking is required.
- To return to O/D (overdrive mode), press the transmission control switch. The O/D OFF lamp will not be illuminated.
- O/D (Overdrive) is automatically returned each time the key is turned off.

2 (Second)

This position allows for second gear only.

- Provides engine braking.
- Use to start-up on slippery roads.
- To return to **D** (Overdrive), move the gearshift lever into the **D** (Overdrive) position.
- Selecting 2 (Second) at higher speeds will cause the transmission to downshift to second gear at the appropriate vehicle speed.

1 (First)

- Provides maximum engine braking.
- Allows upshifts by moving gearshift lever.
- Will not downshift into 1 (First) at high speeds; allows for 1 (First) when vehicle reaches slower speeds.

Forced downshifts

- Allowed in **D** (Overdrive) or Drive.
- Depress the accelerator to the floor.
- Allows transmission to select an appropriate gear.

If your vehicle gets stuck in mud or snow

If your vehicle gets stuck in mud or snow, it may be rocked out by shifting between forward and reverse gears, stopping between shifts in a steady pattern. Press lightly on the accelerator in each gear.

Do not rock the vehicle if the engine is not at normal operating temperature or damage to the transmission may occur.

Do not rock the vehicle for more than a minute or damage to the transmission and tires may occur, or the engine may overheat.

DRIVING THROUGH WATER

If driving through deep or standing water is unavoidable, proceed very slowly especially when the depth is not known. Never drive through water that is higher than the bottom of the wheel rims (for cars) or the bottom of the hubs (for trucks).

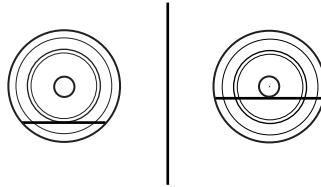

When driving through water, traction or brake capability may be limited. Also, water may enter your engine's air intake and severely damage your engine or your vehicle may stall. **Driving through deep water where the transmission vent tube is submerged may allow water into the transmission and cause internal transmission damage.**

Once through the water, always dry the brakes by moving your vehicle slowly while applying light pressure on the brake pedal. Wet brakes do not stop the vehicle as quickly as dry brakes.

Roadside Emergencies

ROADSIDE ASSISTANCE

Getting roadside assistance

To fully assist you should you have a vehicle concern, Ford Motor Company offers a complimentary roadside assistance program. This program is separate from the New Vehicle Limited Warranty. The service is available:

- 24-hours, seven days a week
- for the coverage period listed on the Roadside Assistance Card included in your Owner Guide portfolio.

Roadside assistance will cover:

- a flat tire change with a good spare (except vehicles that have been supplied with a tire inflation kit)
- battery jump start
- lock-out assistance (key replacement cost is the customer's responsibility)
- fuel delivery – Independent Service Contractors, if not prohibited by state, local or municipal law shall deliver up to 2.0 gallons (7.5L) of gasoline or 5 gallons (18.9L) of diesel fuel to a disabled vehicle. Fuel delivery service is limited to two no-charge occurrences within a 12-month period.
- winch out – available within 100 feet (30.5 meters) of a paved or county maintained road, no recoveries.
- towing – Ford/Mercury/Lincoln eligible vehicle towed to an authorized dealer within 35 miles (56.3 km) of the disablement location or to the nearest authorized dealer. If a member requests to be towed to an authorized dealer more than 35 miles (56.3 km) from the disablement location, the member shall be responsible for any mileage costs in excess of 35 miles (56.3 km).

Trailers shall be covered up to \$200 if the disabled eligible vehicle requires service at the nearest authorized dealer. If the trailer is disabled, but the towing vehicle is operational, the trailer does not qualify for any roadside services.

Roadside Emergencies

Canadian customers refer to your Customer Information Guide for information on:

- coverage period
- exact fuel amounts
- towing of your disabled vehicle
- emergency travel expense reimbursement
- travel planning benefits

In Canada, for uninterrupted Roadside Assistance coverage, you may purchase extended coverage prior to your Basic Warranty's Roadside Assistance expiring. For more information and enrollment, contact 1-877-294-2582 or visit our website at www.ford.ca.

Using roadside assistance

Complete the roadside assistance identification card and place it in your wallet for quick reference. In the United States, this card is found in the Owner Guide portfolio in the glove compartment. In Canada, the card is found in the *Customer Information Guide* in the glove compartment.

U.S. Ford, Mercury and Lincoln vehicle customers who require Roadside Assistance, call 1-800-241-3673.

Canadian customers who require roadside assistance, call 1-800-665-2006.

If you need to arrange roadside assistance for yourself, Ford Motor Company will reimburse a reasonable amount for towing to the nearest dealership within 35 miles. To obtain reimbursement information, U.S. Ford, Mercury and Lincoln vehicle customers call 1-800-241-3673. Customers will be asked to submit their original receipts.

Canadian customers who need to obtain reimbursement information, call 1-800-665-2006.

HAZARD FLASHER

Use only in an emergency to warn traffic of vehicle breakdown, approaching danger, etc. The hazard flashers can be operated when the ignition is off.

Roadside Emergencies

- The hazard lights control is located on top of the steering column.
- Depress hazard lights control to activate all hazard flashers simultaneously.
- Depress control again to turn the flashers off.

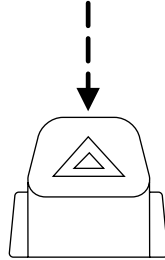

FUEL PUMP SHUT-OFF SWITCH FUEL RESET

The fuel pump shut-off switch is a device intended to stop the electric fuel pump when your vehicle has been involved in a substantial jolt. After a collision, if the engine cranks but does not start, the fuel pump shut-off switch may have been activated.

The fuel pump shut-off switch is located on the left side of the trunk behind the left rear tail light and the trunk liner.

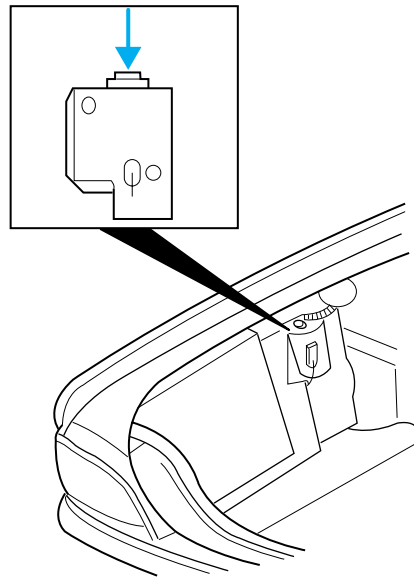

Use the following procedure to reset the fuel pump shut-off switch.

1. Turn the ignition to the off position.
2. Check the fuel system for leaks.

Roadside Emergencies

3. If no fuel leak is apparent, reset the fuel pump shut-off switch by pushing in on the reset button.
4. Turn the ignition to the on position. Pause for a few seconds and return the key to the OFF position.
5. Make a further check for leaks in the fuel system.

FUSES AND RELAYS

Fuses

If electrical components in the vehicle are not working, a fuse may have blown. Blown fuses are identified by a broken wire within the fuse. Check the appropriate fuses before replacing any electrical components.

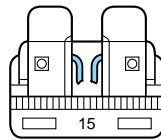

Note: Always replace a fuse with one that has the specified amperage rating. Using a fuse with a higher amperage rating can cause severe wire damage and could start a fire.

Standard fuse amperage rating and color

COLOR					
Fuse rating	Mini fuses	Standard fuses	Maxi fuses	Cartridge maxi fuses	Fuse link cartridge
2A	Grey	Grey	—	—	—
3A	Violet	Violet	—	—	—
4A	Pink	Pink	—	—	—
5A	Tan	Tan	—	—	—
7.5A	Brown	Brown	—	—	—
10A	Red	Red	—	—	—
15A	Blue	Blue	—	—	—
20A	Yellow	Yellow	Yellow	Blue	Blue
25A	Natural	Natural	—	—	—
30A	Green	Green	Green	Pink	Pink
40A	—	—	Orange	Green	Green

Roadside Emergencies

COLOR					
Fuse rating	Mini fuses	Standard fuses	Maxi fuses	Cartridge maxi fuses	Fuse link cartridge
50A	—	—	Red	Red	Red
60A	—	—	Blue	Yellow	Yellow
70A	—	—	Tan	—	Brown
80A	—	—	Natural	Black	Black

Passenger compartment fuse panel

The fuse panel is located below and to the left of the steering wheel by the brake pedal. Remove the panel cover to access the fuses.

To remove a fuse use the fuse puller tool provided on the fuse panel cover.

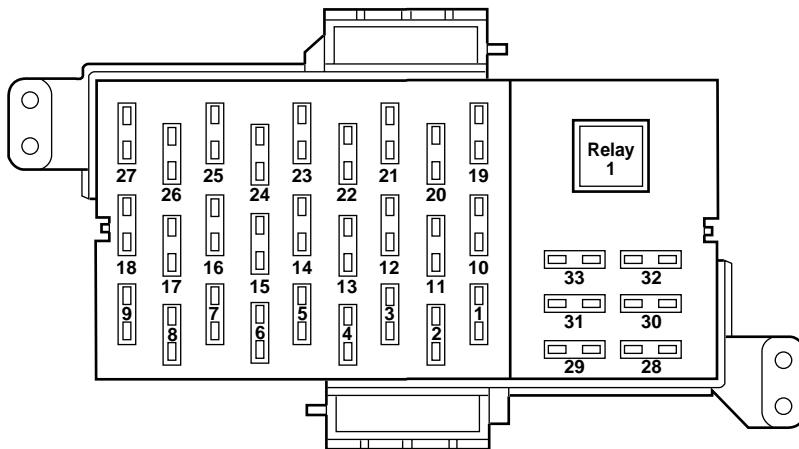

The fuses are coded as follows.

Roadside Emergencies

Fuse/Relay Location	Fuse Amp Rating	Protected Circuits
1	10A	Ignition (START) - Starter relay coil, DTRS
2	7.5A	Power mirrors, Mirror switch, Keypad switch, Decklid switch, DDM, Cluster
3	5A	Ignition (START) - Audio mute, Police PDB (Police vehicles only)
4	10A	LCM (switch illumination), Autolamp sensor
5	7.5A	Ignition (ON/ACC) - LCM
6	7.5A	LCM
7	10A	Ignition (ON/ACC) - Wiper module
8	10A	Electronic Automatic Temperature Control (EATC) module (vehicles equipped with EATC only)
9	7.5A	Ignition (ON/ACC) - Door lock switch illumination, Heated seat switch illumination, Radio, Antenna, Electrochromatic mirror, Window relay coil (non-Police vehicles only), Window and decklid relay coil and Police ON/ACC relay coil (Police vehicles only)
10	15A	Hazards (non-Police vehicles only)
	20A	Hazards (Police vehicles only)
11	15A	Ignition (ON) - Turn signals
12	15A	Audio
13	10A	Ignition (ON) - Rear Air Suspension Module (RASM), Cluster

Roadside Emergencies

Fuse/Relay Location	Fuse Amp Rating	Protected Circuits
14	15A	Taxi, Adjustable pedals
15	10A	Ignition (ON) - EATC module, A/C mode switch (vehicles equipped with manual A/C only), A/C blower relay coil
16	20A	OBD II
17	10A	Ignition (ON) - A/C mode switch (vehicles equipped with manual A/C), Blend door, Heated seat modules
18	15A	Lighting control module (interior lighting)
19	10A	LCM (Left-hand low beam)
20	10A	Ignition (ON/START) - Back-up lamps, Anti-lock Brake system (ABS)
21	10A	LCM (Right-hand low beam)
22	10A	Ignition (ON/START) - Restraint Control Module (RCM), Occupant Classification Sensor (OCS), Passenger Airbag Deactivation Indicator (PADI)
23	15A	Multi-function switch (Flash-to-pass), LCM (High beams)
24	10A	Ignition (ON/START) - Passive Anti-Theft System (PATS) module, Powertrain Control Module (PCM) relay coil, Fuel relay coil, Ignition relay coil
25	15A	LCM (Park lamps, license lamps)

Roadside Emergencies

Fuse/Relay Location	Fuse Amp Rating	Protected Circuits
26	10A	Ignition (ON/START) - Cluster, LCM, Overdrive cancel switch, Traction control switch
27	—	Not used
28	7.5A	Brake signal, LCM (BTSD), ABS
29	2A	Hazard in (Police vehicles only)
30	2A	Battery saver (Police vehicles only)
31	5A	Key in (LCM)
32	2A	Hazard out (Police vehicles only)
33	10A	Fire suppression module (if equipped) (Police vehicles only)
Relay 1	Full ISO relay	Window relay, Decklid (Police vehicles only)

Power distribution box

The power distribution box is located in the engine compartment. The power distribution box contains high-current fuses that protect your vehicle's main electrical systems from overloads.



WARNING: Always disconnect the battery before servicing high current fuses.



WARNING: To reduce risk of electrical shock, always replace the cover to the Power Distribution Box before reconnecting the battery or refilling fluid reservoirs.

If the battery has been disconnected and reconnected, refer to the *Battery* section of the *Maintenance and Specifications* chapter.

Roadside Emergencies

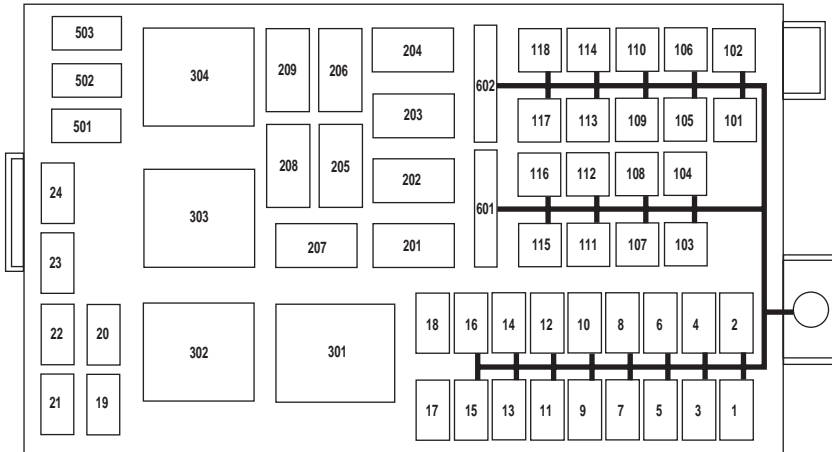

The high-current fuses are coded as follows.

Fuse/Relay Location	Fuse Amp Rating	Protected Circuits
1	30A*	Ignition switch
2	20A*	Spot lights (Police vehicles only)
3	10A*	Powertrain Control Module (PCM) keep alive power, Canister vent
4	20A*	Fuel relay feed
5	10A*	Rear Air Suspension Module (RASM)
6	15A*	Alternator regulator
7	30A*	PCM relay feed
8	20A*	Driver's Door Module (DDM)
9	15A*	Ignition coil relay feed
10	20A*	Horn relay feed
11	15A*	A/C clutch relay feed

Roadside Emergencies

Fuse/Relay Location	Fuse Amp Rating	Protected Circuits
12	20A*	Audio (Subwoofer)
	25A*	Police tray lamps (Police vehicles only)
13	20A*	Instrument panel power point
14	20A*	Stop lamp switch
15	15A*	Police accessory battery feed 1 (Police vehicles only)
16	20A*	Police accessory battery feed 2 (Police vehicles only)
17	10A*	Commercial R/A
18	10A*	Commercial R/A
19	15A*	Injectors
20	15A*	PCM
21	15A*	Powertrain loads and sensors
22	20A*	Police PDB outputs (Police vehicles only)
23	20A*	Police PDB outputs (Police vehicles only)
24	10A*	Heated mirrors, Rear defrost indicator
101	40A**	Blower relay feed
102	50A**	Cooling fan
103	50A**	Instrument panel (I/P) fuse box feed #1, I/P fuses 10, 12, 14, 16 and 18
104	50A**	Instrument panel (I/P) fuse box feed #2, I/P fuses 2, 4, 6, 8, 19, 21, 23 and 25
105	30A**	Starter relay feed
106	40A**	Anti-lock Brake System (ABS) module (Pump)
107	40A**	Rear defroster relay feed

Roadside Emergencies

Fuse/Relay Location	Fuse Amp Rating	Protected Circuits
108	20A**	Police accessory battery feed 3 (Police vehicles only), Cigar lighter (Non-police vehicles only)
109	20A**	ABS module (Valves)
110	30A**	Wiper module
111	50A**	Police PDB or Police accessory battery feed (Police vehicles only)
112	30A**	Air suspension compressor (non-Police vehicles only)
	40A**	Police PDB relay feed (Police vehicles only)
113	50A**	Police light bar or Police right-hand kick panel accessory battery feed (Police vehicles only)
114	50A**	Police PDB or Police accessory battery feed (Police vehicles only)
115	50A**	Rear power point or Police right-hand kick panel accessory battery feed (Police vehicles only)
116	50A**	Police accessory battery feed (Police vehicles only)
117	50A**	Police PDB or Police accessory battery feed (Police vehicles only)
118	50A**	Rear power point or Police right-hand kick panel accessory battery feed (Police vehicles only)
201	½ ISO relay	A/C clutch
202	—	Not used
203	½ ISO relay	Ignition coil
204	½ ISO relay	PCM
205	—	Not used
206	½ ISO relay	Fuel

Roadside Emergencies

Fuse/Relay Location	Fuse Amp Rating	Protected Circuits
207	—	Not used
208	—	Not used
209	½ ISO relay	Horn
301	Full ISO relay	Starter
302	Full ISO relay	Air compressor (non-Police vehicles only)
		RUN/ACC relay (Police vehicles only)
303	Full ISO relay	Blower
304	Full ISO relay	Rear defrost relay
501	—	Not used
502	Diode	PCM
503	—	Not used
601	20A Circuit breaker	Power seats, Lumbar, Decklid (Police vehicles only)
602	20A Circuit breaker	RUN/ACC relay (windows) (non-Police vehicles only)
		RUN/ACC relay feed (windows and decklid) (Police vehicles only)
* Mini fuse ** Cartridge fuse		

Relays

Relays are located in the power distribution box and should be replaced by an authorized dealer.

CHANGING A FLAT TIRE

If you get a flat tire while driving:

- do not brake heavily.
- gradually decrease the vehicle's speed.
- hold the steering wheel firmly.
- slowly move to a safe place on the side of the road.

Your vehicle may be equipped with a conventional spare tire that is different in one or more of the following: type, brand, size, speed rating

Roadside Emergencies

and tread design. If this is the case, this dissimilar spare tire is still rated for your vehicle loads (GAWR and GVWR). This temporary spare tire is not equipped with a Tire Pressure Monitor System (TPMS) sensor.

Note: The tire pressure monitoring system (TPMS) indicator light will illuminate when the spare is in use. To restore the full functionality of the TPMS system, all road wheels equipped with the tire pressure monitoring sensors must be mounted on the vehicle.

Have a flat tire serviced by an authorized dealer in order to prevent damage to the TPMS sensor, refer to *Tire Pressure Monitoring System (TPMS)* in the *Tires, Wheels, and Loading* chapter. Replace the spare tire with a road tire as soon as possible. During repairing or replacing of the flat tire, have the authorized dealer inspect the TPMS sensor for damage.



WARNING: The use of tire sealants may damage your Tire Pressure Monitoring System and should not be used.



WARNING: Refer to *Tire Pressure Monitoring System (TPMS)* in the *Tire, Wheels and Loading* chapter for important information. If the tire pressure monitor sensor becomes damaged, it will no longer function.

Dissimilar spare tire/wheel information



WARNING: Failure to follow these guidelines could result in an increased risk of loss of vehicle control, injury or death.

If you have a dissimilar spare tire/wheel, then it is intended for temporary use only. This means that if you need to use it, you should replace it as soon as possible with a road tire/wheel that is the same size and type as the road tires and wheels that were originally provided by Ford. If the dissimilar spare tire or wheel is damaged, it should be replaced rather than repaired.

A dissimilar spare tire/wheel is defined as a spare tire and/or wheel that is different in brand, size or appearance from the road tires and wheels and can be one of three types:

1. **T-type mini-spare:** This spare tire begins with the letter “T” for tire size and may have “Temporary Use Only” molded in the sidewall
2. **Full-size dissimilar spare with label on wheel:** This spare tire has a label on the wheel that states: “THIS TIRE AND WHEEL FOR TEMPORARY USE ONLY”

Roadside Emergencies

When driving with one of the dissimilar spare tires listed above, **do not:**

- Exceed 50 mph (80 km/h)
- Load the vehicle beyond maximum vehicle load rating listed on the Safety Compliance Label
- Tow a trailer
- Use snow chains on the end of the vehicle with the dissimilar spare tire
- Use more than one dissimilar spare tire at a time
- Use commercial car washing equipment
- Try to repair the dissimilar spare tire

Use of one of the dissimilar spare tires listed above at any one wheel location can lead to impairment of the following:

- Handling, stability and braking performance
- Comfort and noise
- Ground clearance and parking at curbs
- Winter weather driving capability
- Wet weather driving capability

3. Full-size dissimilar spare without label on wheel

When driving with the full-size dissimilar spare tire/wheel, **do not:**

- Exceed 70 mph (113 km/h)
- Use more than one dissimilar spare tire/wheel at a time
- Use commercial car washing equipment
- Use snow chains on the end of the vehicle with the dissimilar spare tire/wheel

The usage of a full-size dissimilar spare tire/wheel can lead to impairment of the following:

- Handling, stability and braking performance
- Comfort and noise
- Ground clearance and parking at curbs
- Winter weather driving capability
- Wet weather driving capability
- All-Wheel driving capability (if applicable)
- Load leveling adjustment (if applicable)

Roadside Emergencies

When driving with the full-size dissimilar spare tire/wheel additional caution should be given to:

- Towing a trailer
- Driving vehicles equipped with a camper body
- Driving vehicles with a load on the cargo rack

Drive cautiously when using a full-size dissimilar spare tire/wheel and seek service as soon as possible.

Full-size Matching Spare Tire/Wheel Information

This spare tire/wheel will match the road tire/wheel. When driving with the full size matching spare tire/wheel, do not exceed 70 mph (113 km/h). It is intended for temporary use only. This means if you need to use it, you should replace it as soon as possible.

Stopping and securing the vehicle

1. Park on a level surface, set the parking brake and activate hazard flashers.
2. Place gearshift lever in P (Park) and turn engine off.

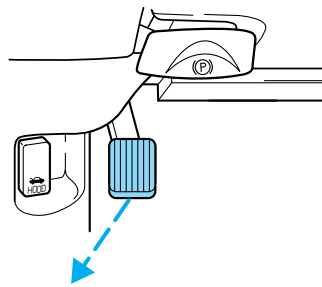

Removing the spare tire and jack

1. Remove the spare tire and the jack. The jack could be located:
 - A — behind the mini spare tire or
 - B — behind the full size spare tire

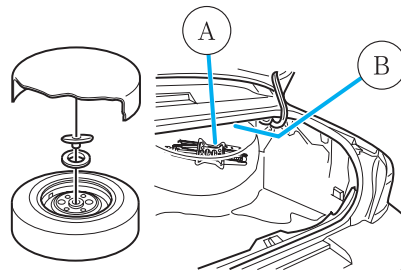

Roadside Emergencies

! **WARNING:** On vehicles equipped with air suspension, turn off the air suspension switch prior to jacking, hoisting or towing your vehicle.

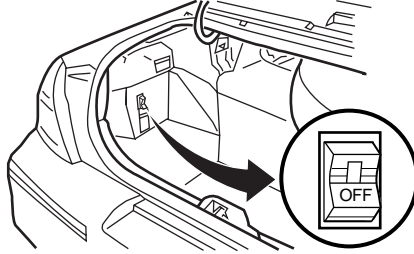

Refer to *Air suspension system* in the *Driving* chapter.

2. Remove the lug wrench from the jack. Rotate the lug wrench socket out from the handle.

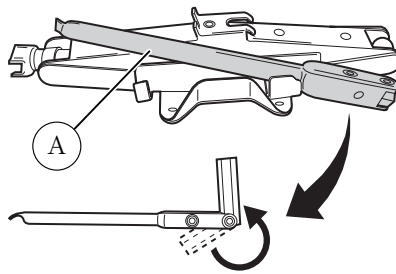

Tire change procedure

! **WARNING:** When one of the front wheels is off the ground, the transmission alone will not prevent the vehicle from moving or slipping off the jack, even if the vehicle is in P (Park).

! **WARNING:** To help prevent the vehicle from moving when you change a tire, be sure the parking brake is set, then block (in both directions) the wheel that is diagonally opposite (other side and end of the vehicle) to the tire being changed.

! **WARNING:** If the vehicle slips off the jack, you or someone else could be seriously injured.

! **WARNING:** Do not attempt to change a tire on the side of the vehicle close to moving traffic. Pull far enough off the road to avoid the danger of being hit when operating the jack or changing the wheel.

Roadside Emergencies

1. Block the diagonally opposite wheel.

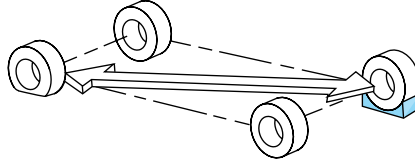

2. Remove any wheel trim. Insert the tapered end of the lug nut wrench behind wheel covers or hubcaps and twist off.

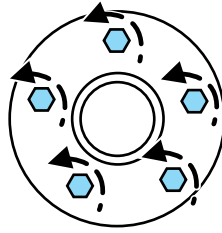

3. Loosen each wheel metal lug nut one-half turn counterclockwise but do not remove them until the wheel is raised off the ground.

STOP Before placing the jack under the vehicle, NOTE the jack location markings:

JACK LOCATION

The jack location markings can be found **on the lower outer edge of the body**.

- Locate the jack locator mark (B) on the body (C) near the tire you are changing, then place the jack (D) **under the frame (A) of the vehicle** aligning it with the mark (B).
- Position the jack according to the following guides and turn the jack handle clockwise until the wheel is completely off the ground.

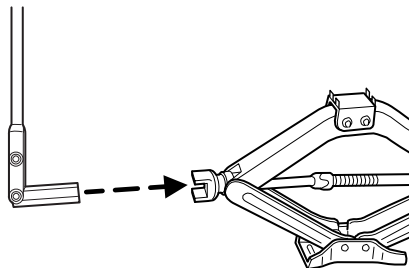
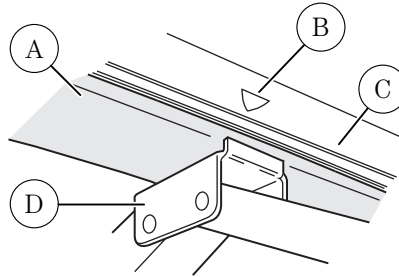

Roadside Emergencies



WARNING: To lessen risk of personal injury, do not put any part of your body under the vehicle while changing a tire. Do not start the engine when your vehicle is on the jack. The jack is ONLY meant for changing the tire.

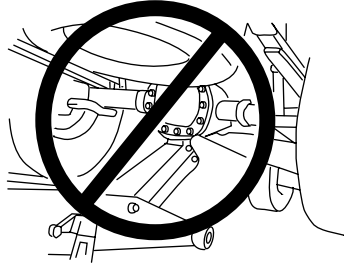

- **Never use the rear differential as a jacking point.**

4. Remove the metal lug nuts with the lug wrench.
5. Replace the flat tire/wheel assembly with the spare tire/wheel assembly, making sure the valve stem is facing outward. Reinstall lug nuts until the wheel is snug against the hub. Do not fully tighten the lug nuts until the wheel has been lowered.
6. Lower the vehicle by turning the jack handle counterclockwise.
7. Remove the jack and fully tighten the lug nuts in the order shown. Refer to *Wheel lug nut torque specifications* later in this chapter for the proper lug nut torque specification.
8. Install any wheel covers, ornaments or hub caps. Make sure they are snapped in place.
9. Put flat tire, jack and lug wrench away.
10. Turn on the air suspension switch (if equipped).

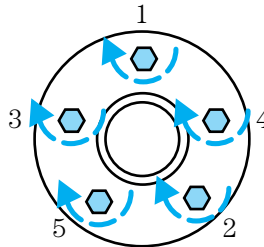

WHEEL LUG NUT TORQUE SPECIFICATIONS

Retighten the lug nuts to the specified torque within 100 miles (160 km) after any wheel disturbance (tire rotation, changing a flat tire, wheel removal, etc.).

Roadside Emergencies

Bolt size	Wheel lug nut torque*	
	lb.ft.	N•m
½ x 20	100	135

* Torque specifications are for nut and bolt threads free of dirt and rust. Use only Ford recommended replacement fasteners.

! WARNING: When a wheel is installed, always remove any corrosion, dirt or foreign materials present on the mounting surfaces of the wheel or the surface of the wheel hub, brake drum or brake disc that contacts the wheel. Ensure that any fasteners that attach the rotor to the hub are secured so they do not interfere with the mounting surfaces of the wheel. Installing wheels without correct metal-to-metal contact at the wheel mounting surfaces can cause the wheel nuts to loosen and the wheel to come off while the vehicle is in motion, resulting in loss of control.

Note: Inspect the wheel pilot hole prior to installation. If there is visible corrosion in wheel pilot hole, remove loose particles by wiping with clean rag and apply grease. Apply grease only to the wheel pilot hole surface by smearing a “dime” (1 square cm) sized glob of grease around the wheel pilot surface (1) with end of finger. DO NOT apply grease to lugnut/stud holes or wheel-to-brake surfaces.

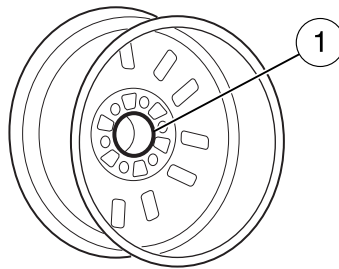

JUMP STARTING

! WARNING: The gases around the battery can explode if exposed to flames, sparks, or lit cigarettes. An explosion could result in injury or vehicle damage.

! WARNING: Batteries contain sulfuric acid which can burn skin, eyes and clothing, if contacted.

Roadside Emergencies

Do not attempt to push-start your automatic transmission vehicle. Automatic transmissions do not have push-start capability. Attempting to push-start a vehicle with an automatic transmission may cause transmission damage.

Preparing your vehicle

When the battery is disconnected or a new battery is installed, the automatic transmission must relearn its shift strategy. As a result, the transmission may have firm and/or soft shifts. This operation is considered normal and will not affect function or durability of the transmission. Over time, the adaptive learning process will fully update transmission operation.

1. **Use only a 12-volt supply to start your vehicle.**
2. Do not disconnect the battery of the disabled vehicle as this could damage the vehicle's electrical system.
3. Park the booster vehicle close to the hood of the disabled vehicle making sure the two vehicles **do not** touch. Set the parking brake on both vehicles and stay clear of the engine cooling fan and other moving parts.
4. Check all battery terminals and remove any excessive corrosion before you attach the battery cables. Ensure that vent caps are tight and level.
5. Turn the heater fan on in both vehicles to protect from any electrical surges. Turn all other accessories off.

Roadside Emergencies

Connecting the jumper cables

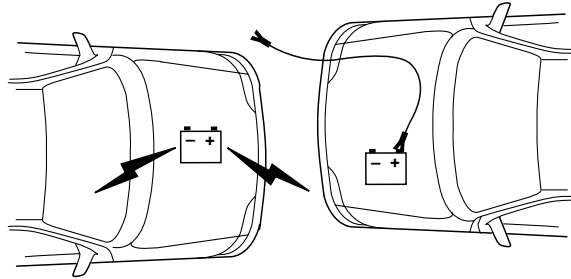

1. Connect the positive (+) jumper cable to the positive (+) terminal of the discharged battery.

Note: In the illustrations, *lightning bolts* are used to designate the assisting (boosting) battery.

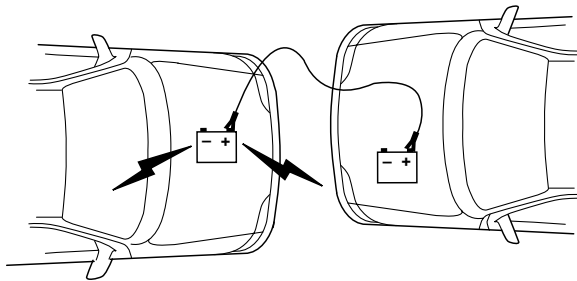

2. Connect the other end of the positive (+) cable to the positive (+) terminal of the assisting battery.

Roadside Emergencies

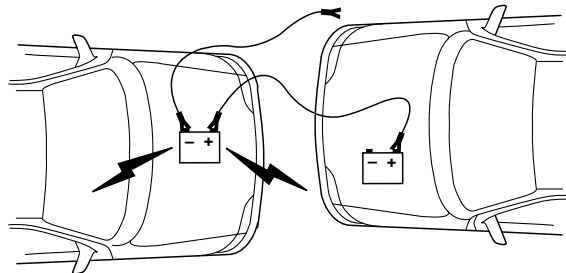

3. Connect the negative (-) cable to the negative (-) terminal of the assisting battery.

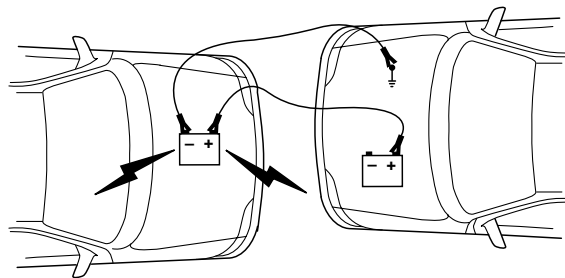

4. Make the final connection of the negative (-) cable to an exposed metal part of the stalled vehicle's engine, away from the battery and the carburetor/fuel injection system. **Do not** use fuel lines, engine rocker covers or the intake manifold as *grounding* points.



WARNING: Do not connect the end of the second cable to the negative (-) terminal of the battery to be jumped. A spark may cause an explosion of the gases that surround the battery.

5. Ensure that the cables are clear of fan blades, belts, moving parts of both engines, or any fuel delivery system parts.

Roadside Emergencies

Jump starting

1. Start the engine of the booster vehicle and run the engine at moderately increased speed.
2. Start the engine of the disabled vehicle.
3. Once the disabled vehicle has been started, run both engines for an additional three minutes before disconnecting the jumper cables.

Removing the jumper cables

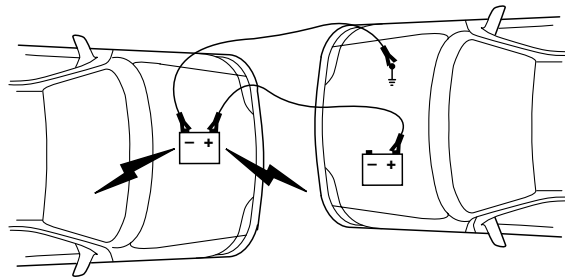

Remove the jumper cables in the reverse order that they were connected.

1. Remove the jumper cable from the *ground* metal surface.

Note: In the illustrations, *lightning bolts* are used to designate the assisting (boosting) battery.

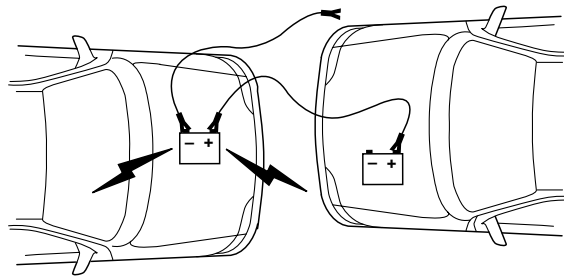

2. Remove the jumper cable on the negative (-) connection of the booster vehicle's battery.

Roadside Emergencies

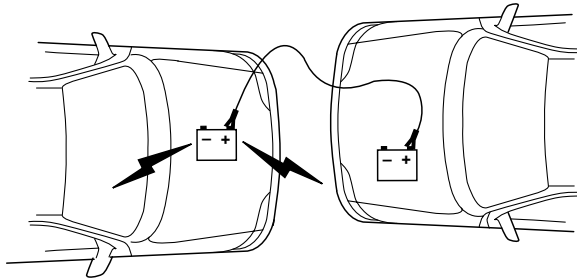

3. Remove the jumper cable from the positive (+) terminal of the booster vehicle's battery.

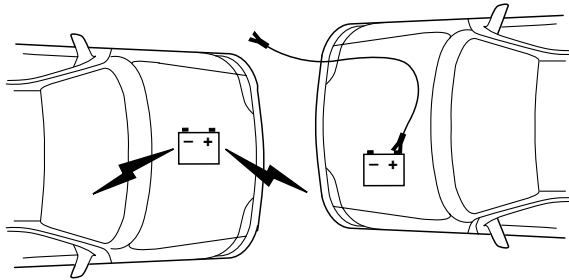

4. Remove the jumper cable from the positive (+) terminal of the disabled vehicle's battery.

After the disabled vehicle has been started and the jumper cables removed, allow it to idle for several minutes so the engine computer can *relearn* its idle conditions.

Roadside Emergencies

WRECKER TOWING

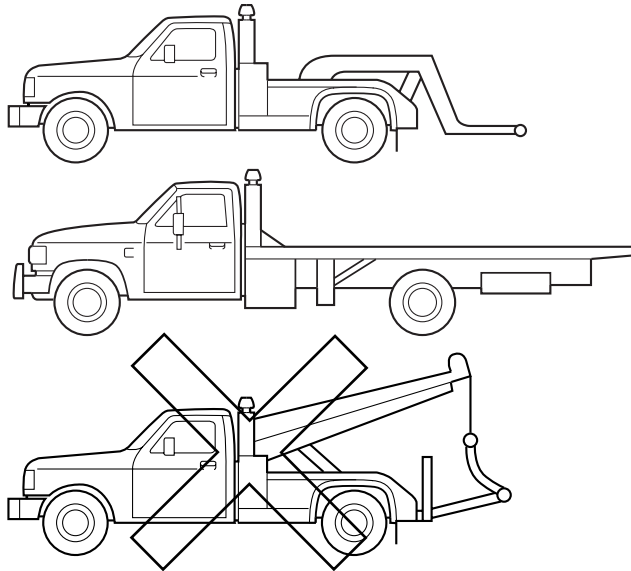

If you need to have your vehicle towed, contact a professional towing service or, if you are a member of a roadside assistance program, your roadside assistance service provider.

It is recommended that your vehicle be towed with a wheel lift or flatbed equipment. Do not tow with a slingbelt. Ford Motor Company has not approved a slingbelt towing procedure.

If equipped with an air suspension system, the air suspension control in the luggage compartment must be turned to the off position before your vehicle can be towed.

If the vehicle is towed by other means or incorrectly, vehicle damage may occur.

Ford Motor Company produces a towing manual for all authorized tow truck operators. Have your tow truck operator refer to this manual for proper hook-up and towing procedures for your vehicle.

Roadside Emergencies

Emergency towing

In case of a roadside emergency with a disabled vehicle (without access to wheel dollies, car hauling trailer, or flatbed transport vehicle) your vehicle (regardless of transmission powertrain configuration) can be flat towed (all wheels on the ground) under the following conditions:

- Vehicle is facing forward so that it is being towed in a forward direction.
- Place the transmission in N (Neutral). Refer to *Brake shift interlock* in the *Driving* chapter for specific instructions if you cannot move the gear shift lever into N (Neutral).
- Maximum speed is not to exceed 35 mph (56 km/h).
- Maximum distance is 50 miles (80 km).

Customer Assistance

GETTING THE SERVICES YOU NEED

Warranty repairs to your vehicle must be performed by an authorized Ford, Lincoln, or Mercury dealer. While any authorized dealer handling your vehicle line will provide warranty service, we recommend you return to your selling authorized dealer who wants to ensure your continued satisfaction.

Please note that certain warranty repairs require special training and/or equipment, so not all authorized dealers are authorized to perform all warranty repairs. This means that, depending on the warranty repair needed, you may have to take your vehicle to another authorized dealer.

A reasonable time must be allowed to perform a repair after taking your vehicle to the authorized dealer. Repairs will be made using Ford or Motorcraft parts, or remanufactured or other parts that are authorized by Ford.

Away from home

If you are away from home when your vehicle needs service, contact the Ford Customer Relationship Center or use the online resources listed below to find the nearest authorized dealer.

In the United States:

Mailing Address

Ford Motor Company
Customer Relationship Center
P.O. Box 6248
Dearborn, MI 48121

Telephone

1-800-392-3673 (FORD)
(TDD for the hearing impaired: 1-800-232-5952)

Online

Additional information and resources are available online at www.genuineservice.com.

- U.S. dealer locator by Dealer Name, City/State, or Zip Code
- Owner Guides
- Maintenance Schedules
- Recalls
- Ford Extended Service Plans
- Ford Genuine Accessories
- Service specials and promotions.

Customer Assistance

In Canada:

Mailing Address (Ford vehicles)

Customer Relationship Centre
Ford Motor Company of Canada, Limited
P.O. Box 2000
Oakville, Ontario L6J 5E4

Telephone

1-800-565-3673 (FORD)

Online

www.ford.ca

Mailing Address (Lincoln vehicles)

Lincoln Centre
Ford Motor Company of Canada, Limited
P.O. Box 2000
Oakville, Ontario L6J 5E4

Telephone

1-800-387-9333

Online

www.lincolncanada.com

Additional Assistance

If you have questions or concerns, or are unsatisfied with the service you are receiving, follow these steps:

1. Contact your Sales Representative or Service Advisor at your selling/servicing authorized dealer.
2. If your inquiry or concern remains unresolved, contact the Sales Manager, Service Manager or Customer Relations Manager.
3. If you require assistance or clarification on Ford Motor Company policies, please contact the Ford Customer Relationship Center

In order to help you serve you better, please have the following information available when contacting a Customer Relationship Center:

- Vehicle Identification Number (VIN)
- Your telephone number (home and business)
- The name of the authorized dealer and city where located
- The vehicle's current odometer reading

In some states, you must directly notify Ford in writing before pursuing remedies under your state's warranty laws. Ford is also allowed a final repair attempt in some states.

Customer Assistance

In the United States, a warranty dispute must be submitted to the BBB AUTO LINE before taking action under the Magnuson-Moss Warranty Act, or to the extent allowed by state law, before pursuing replacement or repurchase remedies provided by certain state laws. This dispute handling procedure is not required prior to enforcing state created rights or other rights which are independent of the Magnuson-Moss Warranty Act or state replacement or repurchase laws.

IN CALIFORNIA (U.S. ONLY)

California Civil Code Section 1793.2(d) requires that, if a manufacturer or its representative is unable to repair a motor vehicle to conform to the vehicle's applicable express warranty after a reasonable number of attempts, the manufacturer shall be required to either replace the vehicle with one substantially identical or repurchase the vehicle and reimburse the buyer in an amount equal to the actual price paid or payable by the consumer (less a reasonable allowance for consumer use). The consumer has the right to choose whether to receive a refund or replacement vehicle.

California Civil Code Section 1793.22(b) presumes that the manufacturer has had a reasonable number of attempts to conform the vehicle to its applicable express warranties if, within the first 18 months of ownership of a new vehicle or the first 18,000 miles (29,000 km), whichever occurs first:

1. Two or more repair attempts are made on the same non-conformity likely to cause death or serious bodily injury OR
2. Four or more repair attempts are made on the same nonconformity (a defect or condition that substantially impairs the use, value or safety of the vehicle) OR
3. The vehicle is out of service for repair of nonconformities for a total of more than 30 calendar days (not necessarily all at one time)

In the case of 1 or 2 above, the consumer must also notify the manufacturer of the need for the repair of the nonconformity at the following address:

Ford Motor Company
16800 Executive Plaza Drive
Mail Drop 3NE-B
Dearborn, MI 48126

THE BETTER BUSINESS BUREAU (BBB) AUTO LINE PROGRAM (U.S. ONLY)

Your satisfaction is important to Ford Motor Company and to your dealer. If a warranty concern has not been resolved using the three-step

Customer Assistance

procedure outlined on the first page of the *Customer Assistance* section, you may be eligible to participate in the BBB AUTO LINE program.

The BBB AUTO LINE program consists of two parts – mediation and arbitration. During mediation, a representative of the BBB will contact both you and Ford Motor Company to explore options for settlement of the claim. If an agreement is not reached during mediation and your claim is eligible, you may participate in the arbitration process. An arbitration hearing will be scheduled so that you can present your case in an informal setting before an impartial person. The arbitrator will consider the testimony provided and make a decision after the hearing.

You are not bound by the decision, but should you choose to accept the BBB AUTO LINE decision, Ford must abide by the accepted decision as well. Disputes submitted to the BBB AUTO LINE program are usually decided within forty days after you file your claim with the BBB.

BBB AUTO LINE Application: Using the information provided below, please call or write to request a program application. You will be asked for your name and address, general information about your new vehicle, information about your warranty concerns, and any steps you have already taken to try to resolve them. A Customer Claim Form will be mailed that will need to be completed, signed and returned to the BBB along with proof of ownership. Upon receipt, the BBB will review the claim for eligibility under the Program Summary Guidelines.

You can get more information by calling BBB AUTO LINE at 1-800-955-5100, or writing to:

**BBB AUTO LINE
4200 Wilson Boulevard, Suite 800
Arlington, Virginia 22203-1833**

BBB AUTO LINE applications can also be requested by calling the Ford Motor Company Customer Relationship Center at 1-800-392-3673.

Note: Ford Motor Company reserves the right to change eligibility limitations, modify procedures, or to discontinue this process at any time without notice and without obligation.

UTILIZING THE MEDIATION/ARBITRATION PROGRAM (CANADA ONLY)

For vehicles delivered to authorized Canadian dealers. In those cases where you continue to feel that the efforts by Ford of Canada and the authorized dealer to resolve a factory-related vehicle service concern have been unsatisfactory, Ford of Canada participates in an impartial third party mediation/arbitration program administered by the Canadian Motor Vehicle Arbitration Plan (CAMVAP).

Customer Assistance

The CAMVAP program is a straight-forward and relatively speedy alternative to resolve a disagreement when all other efforts to produce a settlement have failed. This procedure is without cost to you and is designed to eliminate the need for lengthy and expensive legal proceedings.

In the CAMVAP program, impartial third-party arbitrators conduct hearings at mutually convenient times and places in an informal environment. These impartial arbitrators review the positions of the parties, make decisions and, when appropriate, render awards to resolve disputes. CAMVAP decisions are fast, fair, and final as the arbitrator's award is binding both to you and Ford of Canada.

CAMVAP services are available in all territories and provinces. For more information, without charge or obligation, call your CAMVAP Provincial Administrator directly at 1-800-207-0685.

FORD EXTENDED SERVICE PLAN

You can get more protection for your new car or light truck by purchasing Ford Extended Service Plan (Ford ESP) coverage. It provides the following:

- Benefits during the warranty period depending on the plan you purchase (such as: reimbursement for rentals; coverage for certain maintenance and wear items).
- Protection against covered repair costs after your Bumper-to-Bumper Warranty expires.

You may purchase Ford ESP from any participating authorized dealer. There are several plans available in various time, distance and deductible combinations which can be tailored to fit your own driving needs. Ford ESP also offers reimbursement benefits for towing and rental coverage.

When you buy Ford ESP, you receive Peace-of-Mind protection throughout the United States and Canada, provided by a network of more than 4,600 participating authorized dealers.

If you did not take advantage of the Ford Extended Service Plan at the time of purchasing your vehicle, you may still be eligible. Since this information is subject to change, please ask your authorized dealer for complete details about Ford Extended Service Plan coverage options, or visit the Ford ESP website at www.ford-esp.com.

GETTING ASSISTANCE OUTSIDE THE U.S. AND CANADA

Before exporting your vehicle to a foreign country, contact the appropriate foreign embassy or consulate. These officials can inform you of local vehicle registration regulations and where to find unleaded fuel.

Customer Assistance

If you cannot find unleaded fuel or can only get fuel with an anti-knock index lower than is recommended for your vehicle, contact a regional office or owner relations/customer relationship office.

The use of leaded fuel in your vehicle without proper conversion may damage the effectiveness of your emission control system and may cause engine knocking or serious engine damage. Ford Motor Company/Ford of Canada is not responsible for any damage caused by use of improper fuel. Using leaded fuel may also result in difficulty importing your vehicle back into the U.S.

If your vehicle must be serviced while you are traveling or living in Central America, the Caribbean, or the Middle East, contact the nearest authorized dealer. If the authorized dealer cannot help you, contact:

FORD MOTOR COMPANY
FORD EXPORT OPERATIONS
1555 Fairlane Drive
Fairlane Business Park #3
Allen Park, Michigan 48101
U.S.A.
Telephone: (313) 594-4857
FAX: (313) 390-0804
Email: expcac@ford.com

If you are in another foreign country, contact the nearest authorized dealer. If the authorized dealer employees cannot help you, they can direct you to the nearest Ford affiliate office.

If you buy your vehicle in North America and then relocate outside of the U.S. or Canada, register your vehicle identification number (VIN) and new address with Ford Motor Company Export Operations.

Customers in the U.S. should call 1-800-392-3673.

ORDERING ADDITIONAL OWNER'S LITERATURE

To order the publications in this portfolio, contact Helm, Incorporated at:

HELM, INCORPORATED
P.O. Box 07150
Detroit, Michigan 48207

Or to order a free publication catalog, call toll free: 1-800-782-4356

Monday-Friday 8:00 a.m. - 6:00 p.m. EST

Helm, Incorporated can also be reached by their website:
www.helminc.com.

(Items in this catalog may be purchased by credit card, check or money order.)

Customer Assistance

Obtaining a French owner's guide

French Owner's Guides can be obtained from your authorized dealer or by writing to:

Ford Motor Company of Canada, Limited
Service Publications CHQ202
The Canadian Road
P.O. Box 2000
Oakville, ON, Canada
L6J 5E4

REPORTING SAFETY DEFECTS (U.S. ONLY)

If you believe that your vehicle has a defect which could cause a crash or could cause injury or death, you should immediately inform the National Highway Traffic Safety



Administration (NHTSA) in addition to notifying Ford Motor Company.

If NHTSA receives similar complaints, it may open an investigation, and if it finds that a safety defect exists in a group of vehicles, it may order a recall and remedy campaign. However, NHTSA cannot become involved in individual problems between you, your dealer, or Ford Motor Company.

To contact NHTSA, you may call the Vehicle Safety Hotline toll-free at 1-888-327-4236 (TTY: 1-800-424-9153); go to <http://www.safercar.gov>; or write to:

Administrator
1200 New Jersey Avenue, Southeast
Washington, D.C. 20590

You can also obtain other information about motor vehicle safety from <http://www.safercar.gov>.

REPORTING SAFETY DEFECTS (CANADA ONLY)

If you believe that your vehicle has a defect which could cause a crash or could cause injury or death, you should immediately inform Transport Canada, using their toll-free number: 1-800-333-0510.

WASHING THE EXTERIOR

Wash your vehicle regularly with cool or lukewarm water and a neutral pH shampoo, such as Motorcraft Detail Wash (ZC-3-A), which is available from your authorized dealer.

- Never use strong household detergents or soap, such as dish washing or laundry liquid. These products can discolor and spot painted surfaces.
- Never wash a vehicle that is “hot to the touch” or during exposure to strong, direct sunlight.
- Always use a clean sponge or car wash mitt with plenty of water for best results.
- Dry the vehicle with a chamois or soft terry cloth towel in order to eliminate water spotting.
- It is especially important to wash the vehicle regularly during the winter months, as dirt and road salt are difficult to remove and cause damage to the vehicle.
- Immediately remove items such as gasoline, diesel fuel, bird droppings and insect deposits because they can cause damage to the vehicle’s paintwork and trim over time. Use Motorcraft Bug and Tar Remover (ZC-42) which is available from your authorized dealer.
- Remove any exterior accessories, such as antennas, before entering a car wash.
- **Suntan lotions and insect repellents can damage any painted surface; if these substances come in contact with your vehicle, wash off as soon as possible.**

Exterior chrome

- Wash the vehicle first, using cool or lukewarm water and a neutral pH shampoo, such as Motorcraft Detail Wash (ZC-3-A).
- Use Motorcraft Custom Bright Metal Cleaner (ZC-15), available from your authorized dealer. Apply the product as you would a wax to clean bumpers and other chrome parts; allow the cleaner to dry for a few minutes, then wipe off the haze with a clean, dry rag.
- **Never use abrasive materials such as steel wool or plastic pads as they can scratch the chrome surface.**
- After polishing chrome bumpers, apply a coating of Motorcraft Premium Liquid Wax (ZC-53-A), available from your authorized dealer, or an equivalent quality product to help protect from environmental effects.

Cleaning

WAXING

- Wash the vehicle first.
- Do not use waxes that contain abrasives; use Motorcraft Premium Liquid Wax (ZC-53-A), which is available from your authorized dealer, or an equivalent quality product.
- Do not allow paint sealant to come in contact with any non-body (low-gloss black) colored trim, such as grained door handles, roof racks, bumpers, side moldings, mirror housings or the windshield cowl area. The paint sealant will “gray” or stain the parts over time.

PAINT CHIPS

Your authorized dealer has touch-up paint to match your vehicle's color. Take your color code (printed on a sticker in the driver's door jamb) to your authorized dealer to ensure you get the correct color.

- Remove particles such as bird droppings, tree sap, insect deposits, tar spots, road salt and industrial fallout before repairing paint chips.
- Always read the instructions before using the products.

ALUMINUM WHEELS AND WHEEL COVERS

Aluminum wheels and wheel covers are coated with a clearcoat paint finish. In order to maintain their shine:

- Clean weekly with Motorcraft Wheel and Tire Cleaner (ZC-37-A), which is available from your authorized dealer. Heavy dirt and brake dust accumulation may require agitation with a sponge. Rinse thoroughly with a strong stream of water.
- Never apply any cleaning chemical to hot or warm wheel rims or covers.
- Some automatic car washes may cause damage to the finish on your wheel rims or covers. Chemical-strength cleaners, or cleaning chemicals, in combination with brush agitation to remove brake dust and dirt, could wear away the clearcoat finish over time.
- Do not use hydrofluoric acid-based or high caustic-based wheel cleaners, steel wool, fuels or strong household detergent.
- To remove tar and grease, use Motorcraft Bug and Tar Remover (ZC-42), available from your authorized dealer.

Cleaning

ENGINE

Engines are more efficient when they are clean because grease and dirt buildup keep the engine warmer than normal. When washing:

- Take care when using a power washer to clean the engine. The high-pressure fluid could penetrate the sealed parts and cause damage.
- Do not spray a hot engine with cold water to avoid cracking the engine block or other engine components.
- Spray Motorcraft Engine Shampoo and Degreaser (ZC-20) on all parts that require cleaning and pressure rinse clean. In Canada use Motorcraft Engine Shampoo (CXC-66-A).

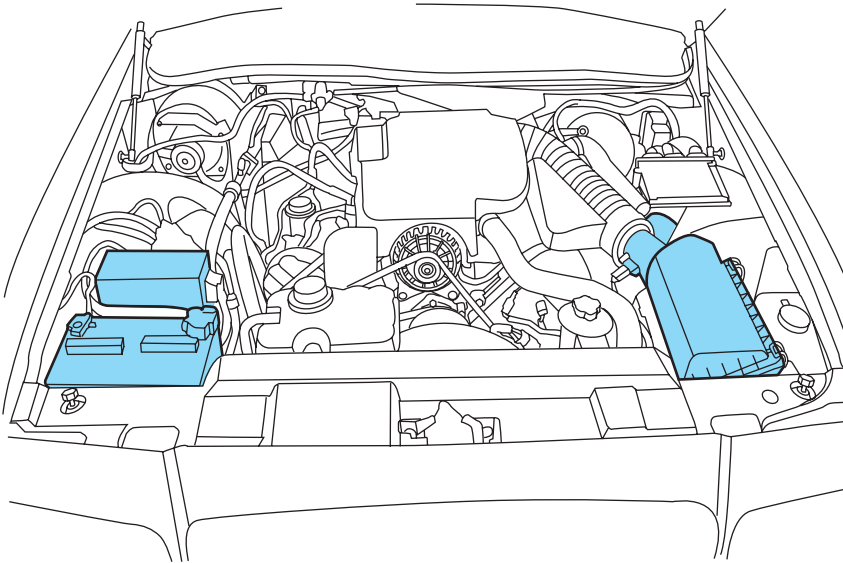

- Cover the highlighted areas to prevent water damage when cleaning the engine.
- Never wash or rinse the engine while it is running; water in the running engine may cause internal damage.

Cleaning

PLASTIC (NON-PAINTED) EXTERIOR PARTS

Use only approved products to clean plastic parts. These products are available from your authorized dealer.

- For routine cleaning, use Motorcraft Detail Wash (ZC-3-A).
- If tar or grease spots are present, use Motorcraft Bug and Tar Remover (ZC-42).
- For plastic headlamp lenses, use Motorcraft Ultra Clear Spray Glass Cleaner (ZC-23).

WINDOWS AND WIPER BLADES

The windshield, rear and side windows and the wiper blades should be cleaned regularly. If the wipers do not wipe properly, substances on the vehicle's glass or the wiper blades may be the cause. These may include hot wax treatments used by commercial car washes, water repellent coatings, tree sap, or other organic contamination; these contaminants may cause squeaking or chatter noise from the blades, and streaking and smearing of the windshield. To clean these items, follow these tips:

- The windshield, rear windows and side windows may be cleaned with a non-abrasive cleaner such as Motorcraft Ultra-Clear Spray Glass Cleaner (ZC-23), available from your authorized dealer.
- The wiper blades can be cleaned with isopropyl (rubbing) alcohol or Motorcraft Premium Windshield Washer Concentrate (ZC-32-A), available from your authorized dealer. This washer fluid contains special solution in addition to alcohol which helps to remove the hot wax deposited on the wiper blade and windshield from automated car wash facilities. Be sure to replace wiper blades when they appear worn or do not function properly.
- Do not use abrasives, as they may cause scratches.
- Do not use fuel, kerosene, or paint thinner to clean any parts.

If you cannot remove those streaks after cleaning with the glass cleaner or if the wipers chatter and move in a jerky motion, clean the outer surface of the windshield and the wiper blades using a sponge or soft cloth with a neutral detergent or mild-abrasive cleaning solution. After cleaning, rinse the windshield and wiper blades with clean water. The windshield is clean if beads do not form when you rinse the windshield with water.

Do not use sharp objects, such as a razor blade, to clean the inside of the rear window or to remove decals, as it may cause damage to the rear window defroster's heated grid lines.

Cleaning

INSTRUMENT PANEL/INTERIOR TRIM AND CLUSTER LENS

Clean the instrument panel, interior trim areas and cluster lens with a clean and damp white cotton cloth, then with a clean and dry white cotton cloth; you may also use Motorcraft Dash & Vinyl Cleaner (ZC-38-A) on the instrument panel and interior trim areas.

- Avoid cleaners or polishes that increase the gloss of the upper portion of the instrument panel. The dull finish in this area helps protect the driver from undesirable windshield reflection.
- Be certain to wash or wipe your hands clean if you have been in contact with certain products such as insect repellent and suntan lotion in order to avoid possible damage to the interior painted surfaces.
- Do not use household or glass cleaners as these may damage the finish of the instrument panel, interior trim and cluster lens.



WARNING: Do not use chemical solvents or strong detergents when cleaning the steering wheel or instrument panel to avoid contamination of the airbag system.

If a staining liquid like coffee/juice has been spilled on the instrument panel or on interior trim surfaces, clean as follows:

1. Wipe up spilled liquid using a clean, white, cotton cloth.
2. Apply Motorcraft Deluxe Leather and Vinyl Cleaner (ZC-11-A) [In Canada use Motorcraft Multi-Purpose Cleaner (CXC-101)] to the wiped area and spread around evenly.
3. Apply more Motorcraft cleaner to a clean, white, cotton cloth and press the cloth onto the soiled area—allow this to set at room temperature for 30 minutes.
4. Remove the soaked cloth, and if it is not soiled badly, use this cloth to clean the area by using a rubbing motion for 60 seconds.
5. Following this, wipe area dry with a clean, white, cotton cloth.

INTERIOR

For fabric, carpets, cloth seats, safety belts and seats equipped with side airbags:

- Remove dust and loose dirt with a vacuum cleaner.
- Remove light stains and soil with Motorcraft Professional Strength Carpet & Upholstery Cleaner (ZC-54).

Cleaning

- If grease or tar is present on the material, spot-clean the area first with Motorcraft Spot and Stain Remover (ZC-14). In Canada, use Motorcraft Multi-Purpose Cleaner (CXC-101).
- If a ring forms on the fabric after spot cleaning, clean the entire area immediately (but do not oversaturate) or the ring will set.
- Do not use household cleaning products or glass cleaners, which can stain and discolor the fabric and affect the flame retardant abilities of the seat materials.



WARNING: Do not use cleaning solvents, bleach or dye on the vehicle's safety belts, as these actions may weaken the belt webbing.



WARNING: On vehicles equipped with seat-mounted airbags, do not use chemical solvents or strong detergents. Such products could contaminate the side-airbag system and affect performance of the side airbag in a collision.

LEATHER SEATS (IF EQUIPPED)

Your leather seating surfaces have a clear, protective coating over the leather.

- For routine cleaning, wipe the surface with a soft, damp cloth. For more thorough cleaning, wipe the surface with a mild soap and water solution. In Canada, use Motorcraft Vinyl Cleaner (CXC-93). Dry the area with a soft cloth.
- If the leather cannot be completely cleaned using a mild soap and water solution, the leather may be cleaned using a commercially available cleaning product designed for automotive leather.
- Do not use household cleaning products, alcohol solutions, solvents or cleaners intended for rubber, vinyl and plastics, or oil/petroleum-based leather conditioners. These products may cause premature wearing of the clear, protective coating.

Note: In some instances, color or dye transfer can occur when wet clothing comes in contact with leather upholstery. If this occurs, the leather should be cleaned immediately to avoid permanent staining.

UNDERBODY

Flush the complete underside of your vehicle frequently. Keep body and door drain holes free from packed dirt.

FORD AND LINCOLN MERCURY CAR CARE PRODUCTS

Your Ford or Lincoln Mercury authorized dealer has many quality products available to clean your vehicle and protect its finishes. These quality products have been specifically engineered to fulfill your automotive needs; they are custom designed to complement the style and appearance of your vehicle. Each product is made from high quality materials that meet or exceed rigid specifications. For best results, use the following products or products of equivalent quality:

- Motorcraft Bug and Tar Remover (ZC-42)
- Motorcraft Car Wash (Canada only) (CXC-83)
- Motorcraft Custom Bright Metal Cleaner (ZC-15)
- Motorcraft Custom Clear Coat Polish (ZC-8-A)
- Motorcraft Custom Vinyl Protectant (ZC-40-A)
- Motorcraft Dash and Vinyl Cleaner (ZC-38-A)
- Motorcraft Deluxe Leather and Vinyl Cleaner (U.S. only) (ZC-11-A)
- Motorcraft Leather Care Kit (U.S. only) (ZC-11-D)
- Motorcraft Detail Wash (ZC-3-A)
- Motorcraft Dusting Cloth (ZC-24)
- Motorcraft Engine Shampoo and Degreaser (U.S. only) (ZC-20)
- Motorcraft Engine Shampoo (Canada only) (CXC-66-A)
- Motorcraft Multi-Purpose Cleaner (Canada only) (CXC-101)
- Motorcraft Premium Glass Cleaner (Canada only) (CXC-100)
- Motorcraft Premium Liquid Wax (ZC-53-A)
- Motorcraft Premium Windshield Washer Concentrate (U.S. only) (ZC-32-A)
- Motorcraft Professional Strength Carpet & Upholstery Cleaner (ZC-54)
- Motorcraft Spot and Stain Remover (U.S. only) (ZC-14)
- Motorcraft Tire Clean and Shine (ZC-28)
- Motorcraft Triple Clean (U.S. only) (ZC-13)
- Motorcraft Ultra-Clear Spray Glass Cleaner (ZC-23)
- Motorcraft Vinyl Cleaner (Canada only) (CXC-93)
- Motorcraft Wash and Wax (Canada only) (CXC-95)
- Motorcraft Wheel and Tire Cleaner (ZC-37-A)

Maintenance and Specifications

SERVICE RECOMMENDATIONS

To help you service your vehicle, we provide *scheduled maintenance information* which makes tracking routine service easy.

If your vehicle requires professional service, your authorized dealer can provide the necessary parts and service. Check your *Warranty Guide/Customer Information Guide* to find out which parts and services are covered.

Use only recommended fuels, lubricants, fluids and service parts conforming to specifications. Motorcraft parts are designed and built to provide the best performance in your vehicle.

Notice to owners of Severe Duty vehicles

Before you have maintenance done on your vehicle, be sure to read the "Severe Duty Owner's Guide Supplement." This book contains important operation and maintenance information.

PRECAUTIONS WHEN SERVICING YOUR VEHICLE

- Do not work on a hot engine.
- Make sure that nothing gets caught in moving parts.
- Do not work on a vehicle with the engine running in an enclosed space, unless you are sure you have enough ventilation.
- Keep all open flames and other burning (cigarettes) material away from the battery and all fuel related parts.

Working with the engine off

1. Set the parking brake and ensure the gearshift is securely latched in P (Park).
2. Turn off the engine and remove the key.
3. Block the wheels to prevent the vehicle from moving unexpectedly.

Maintenance and Specifications

Working with the engine on

1. Set the parking brake and shift to P (Park).
2. Block the wheels.



WARNING: To reduce the risk of vehicle damage and/or personal burn injuries, do not start your engine with the air cleaner removed and do not remove it while the engine is running.

OPENING THE HOOD

1. Inside the vehicle, pull the hood release handle located under the instrument panel.
2. Go to the front of the vehicle and release the auxiliary latch that is located under the front of the hood.
3. Lift the hood until the lift cylinders hold it open.

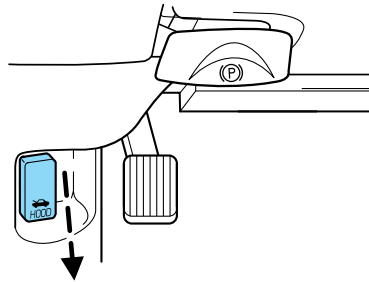

Maintenance and Specifications

IDENTIFYING COMPONENTS IN THE ENGINE COMPARTMENT

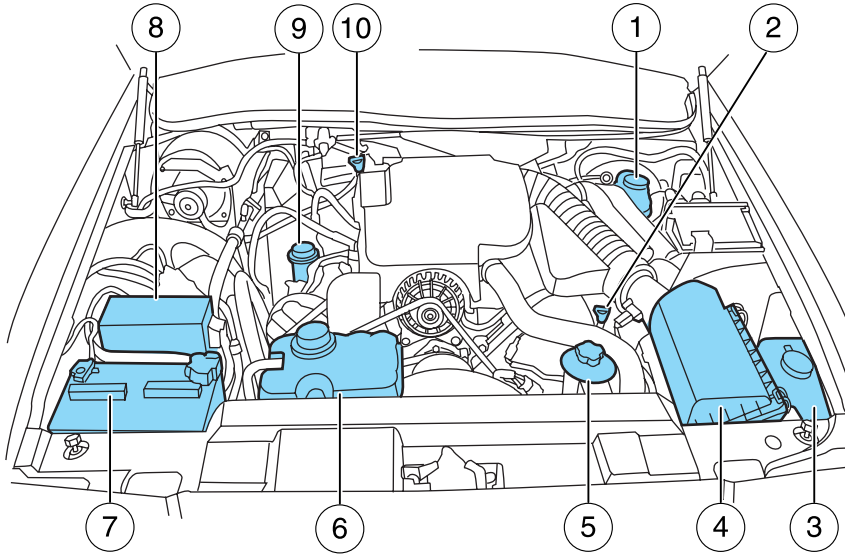

1. Brake fluid reservoir
2. Engine oil dipstick
3. Windshield washer fluid reservoir
4. Air filter assembly
5. Power steering fluid reservoir
6. Engine coolant reservoir
7. Battery
8. Power distribution box
9. Engine oil filler cap
10. Automatic transmission fluid dipstick

Maintenance and Specifications

WINDSHIELD WASHER FLUID

Add fluid to fill the reservoir if the level is low. In very cold weather, do not fill the reservoir completely.

Only use a washer fluid that meets Ford specification WSB-M8B16-A2. Do not use any special washer fluid such as windshield water repellent type fluid or bug wash. They may cause squeaking, chatter noise, streaking and smearing. Refer to the *Maintenance product specifications and capacities* section in this chapter.

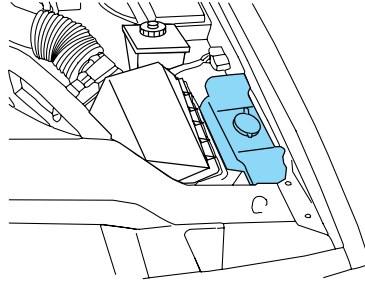

State or local regulations on volatile organic compounds may restrict the use of methanol, a common windshield washer antifreeze additive. Washer fluids containing non-methanol antifreeze agents should be used only if they provide cold weather protection without damaging the vehicle's paint finish, wiper blades or washer system.



WARNING: If you operate your vehicle in temperatures below 40°F (5°C), use washer fluid with antifreeze protection. Failure to use washer fluid with antifreeze protection in cold weather could result in impaired windshield vision and increase the risk of injury or accident.

Note: Do not put washer fluid in the engine coolant reservoir. Washer fluid placed in the cooling system may harm engine and cooling system components.

CHANGING THE WIPER BLADES

1. Pull the wiper blade and arm away from the glass. Turn the blade as much as possible to gain access to the lock tab (A). Using a skinny tool, push the lock tab (A) to release the blade from the arm loop and pull the blade from the arm.
2. Attach the new blade to the arm loop and pull it into place until a click is heard.

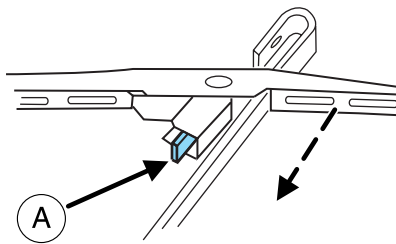

Maintenance and Specifications

Replace wiper blades at least once per year for optimum performance.

Poor wiper quality can be improved by cleaning the wiper blades and the windshield. Refer to *Windows and wiper blades* in the *Cleaning* chapter.

To prolong the life of the wiper blades, it is highly recommended to scrape off the ice on the windshield before turning on the wipers. The layer of ice has many sharp edges and can damage the micro edge of the wiper rubber element.

ENGINE OIL

Checking the engine oil

Refer to the *scheduled maintenance information* for the appropriate intervals for checking the engine oil.

1. Make sure the vehicle is on level ground.
2. Turn the engine off and wait up to 15 minutes for the oil to drain into the oil pan.
3. Set the parking brake and ensure the gearshift is securely latched in P (Park).
4. Open the hood. Protect yourself from engine heat.
5. Locate and carefully remove the engine oil level dipstick.

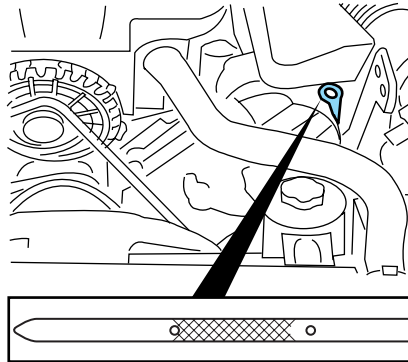

6. Wipe the dipstick clean. Insert the dipstick fully, then remove it again.

Maintenance and Specifications

- If the oil level is **within this range**, the oil level is acceptable. **DO NOT ADD OIL.**

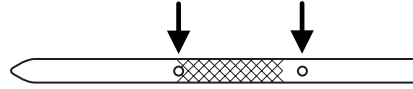

- If the oil level is **below this mark**, engine **oil must be added** to raise the level within the normal operating range.

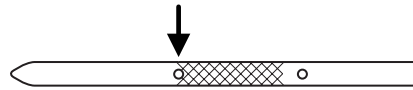

- If required, add engine oil to the engine. Refer to *Adding engine oil* in this chapter.

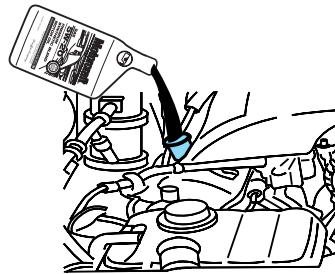

- **Do not overfill the engine with oil. Oil levels above this mark may cause engine damage.** If the engine is overfilled, some oil must be removed from the engine by an authorized dealer.

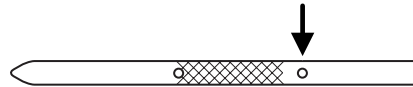

7. Put the dipstick back in and ensure it is fully seated.

Adding engine oil

1. Check the engine oil. For instructions, refer to *Checking the engine oil* in this chapter.
2. If the engine oil level is not within the normal operating range, add only certified engine oil of the recommended viscosity. Remove the engine oil filler cap and use a funnel to pour the engine oil into the opening.
3. Recheck the engine oil level. Make sure the oil level is not above the normal operating range on the engine oil level dipstick.
4. Install the dipstick and ensure it is fully seated.
5. Fully install the engine oil filler cap by turning the filler cap clockwise until three clicks can be heard.

Maintenance and Specifications

To avoid possible oil loss, DO NOT operate the vehicle with the engine oil level dipstick and/or the engine oil filler cap removed.

Engine oil and filter recommendations

Look for this certification trademark.

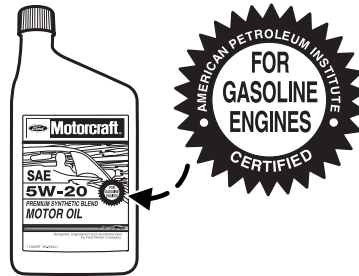

Use SAE 5W-20 engine oil

Only use oils “Certified For Gasoline Engines” by the American Petroleum Institute (API). An oil with this trademark symbol conforms to the current engine and emission system protection standards and fuel economy requirements of the International Lubricant Standardization and Approval Committee (ILSAC), comprised of U.S. and Japanese automobile manufacturers.

To protect your engine and engine’s warranty, use Motorcraft SAE 5W-20 or an equivalent SAE 5W-20 oil meeting Ford specification WSS-M2C930-A. **SAE 5W-20 oil provides optimum fuel economy and durability performance meeting all requirements for your vehicle’s engine.** Refer to *Maintenance product specifications and capacities* later in this chapter for more information.

Do not use supplemental engine oil additives, cleaners or other engine treatments. They are unnecessary and could lead to engine damage that is not covered by Ford warranty.

Change your engine oil and filter according to the appropriate schedule listed in the *scheduled maintenance information*.

Ford production and Motorcraft replacement oil filters are designed for added engine protection and long life. If a replacement oil filter is used that does not meet Ford material and design specifications, start-up engine noises or knock may be experienced.

It is recommended you use the appropriate Motorcraft oil filter or another with equivalent performance for your engine application.

Maintenance and Specifications

BATTERY

Your vehicle is equipped with a Motorcraft maintenance-free battery which normally does not require additional water during its life of service.

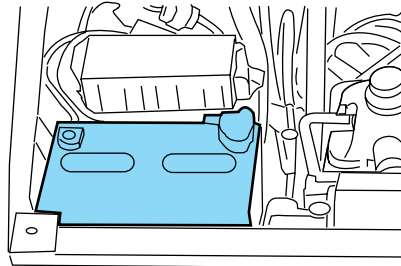

If your battery has a cover/shield, make sure it is reinstalled after the battery has been cleaned or replaced.

For longer, trouble-free operation, keep the top of the battery clean and dry. Also, make certain the battery cables are always tightly fastened to the battery terminals.

If you see any corrosion on the battery or terminals, remove the cables from the terminals and clean with a wire brush. You can neutralize the acid with a solution of baking soda and water.

It is recommended that the negative battery cable terminal be disconnected from the battery if you plan to store your vehicle for an extended period of time. This will minimize the discharge of your battery during storage.

Note: Electrical or electronic accessories or components added to the vehicle by the dealer or the owner may adversely affect battery performance and durability.



WARNING: Batteries normally produce explosive gases which can cause personal injury. Therefore, do not allow flames, sparks or lighted substances to come near the battery. When working near the battery, always shield your face and protect your eyes. Always provide proper ventilation.



WARNING: When lifting a plastic-cased battery, excessive pressure on the end walls could cause acid to flow through the vent caps, resulting in personal injury and/or damage to the vehicle or battery. Lift the battery with a battery carrier or with your hands on opposite corners.

Maintenance and Specifications



WARNING: Keep batteries out of reach of children. Batteries contain sulfuric acid. Avoid contact with skin, eyes or clothing. Shield your eyes when working near the battery to protect against possible splashing of acid solution. In case of acid contact with skin or eyes, flush immediately with water for a minimum of 15 minutes and get prompt medical attention. If acid is swallowed, call a physician immediately.



WARNING: Battery posts, terminals and related accessories contain lead and lead compounds. **Wash hands after handling.**

Battery relearn

Because your vehicle's engine is electronically controlled by a computer, some control conditions are maintained by power from the battery. When the battery is disconnected or a new battery is installed, the engine must relearn its idle and fuel trim strategy for optimum driveability and performance. Flexible fuel vehicles (FFV) must also relearn the ethanol content of the fuel for optimum driveability and performance. To begin this process:

1. With the vehicle at a complete stop, set the parking brake.
2. Put the gearshift in P (Park), turn off all accessories and start the engine.
3. Run the engine until it reaches normal operating temperature.
4. Allow the engine to idle for at least one minute.
5. Turn the A/C on and allow the engine to idle for at least one minute.
6. Release the parking brake. With your foot on the brake pedal and with the A/C on, put the vehicle in D (Drive) and allow the engine to idle for at least one minute.
7. Drive the vehicle to complete the relearning process.
 - The vehicle may need to be driven 10 miles (16 km) or more to relearn the idle and fuel trim strategy along with the ethanol content for flexible fuel vehicles.
 - If you do not allow the engine to relearn its idle trim, the idle quality of your vehicle may be adversely affected until the idle trim is eventually relearned.
 - For flexible fuel vehicles, if you are operating on E85, you may experience poor starts or an inability to start the engine and driveability problems until the fuel trim and ethanol content have been relearned.

Maintenance and Specifications

If the battery has been disconnected or a new battery has been installed, the clock and radio settings must be reset once the battery is reconnected.

- Always dispose of automotive batteries in a responsible manner. Follow your local authorized standards for disposal. Call your local authorized recycling center to find out more about recycling automotive batteries.

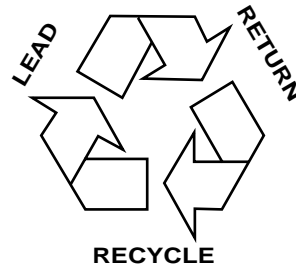

ENGINE COOLANT

Checking engine coolant

The concentration and level of engine coolant should be checked at the intervals listed in *scheduled maintenance information*. The coolant concentration should be maintained at 50/50 coolant and distilled water, which equates to a freeze point of -34°F (-36°C). Coolant concentration testing is possible with a hydrometer or antifreeze tester. The level of coolant should be maintained at the "FULL COLD" level or within the "COLD FILL RANGE" in the coolant reservoir. If the level falls below, add coolant per the instructions in the *Adding engine coolant* section.

Your vehicle was factory-filled with a 50/50 engine coolant and water concentration. If the concentration of coolant falls below 40% or above 60%, the engine parts could become damaged or not work properly. **A 50/50 mixture of coolant and water provides the following:**

- **Freeze protection down to -34°F (-36°C).**
- **Boiling protection up to 265°F (129°C).**
- **Protection against rust and other forms of corrosion.**
- **Proper function of calibrated gauges.**

Maintenance and Specifications

When the engine is cold, check the level of the engine coolant in the reservoir.

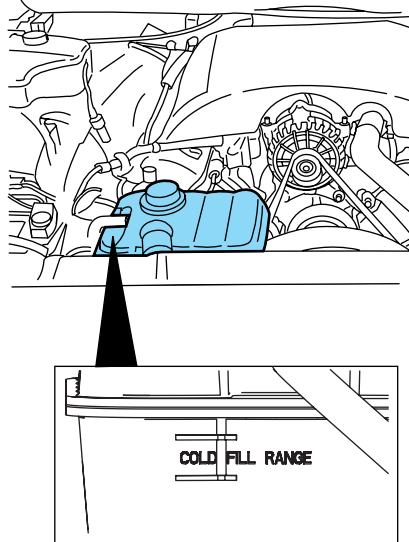

- The engine coolant should be at the “FULL COLD” level or within the “COLD FILL RANGE” as listed on the engine coolant reservoir (depending upon application).
- Refer to *scheduled maintenance information* for service interval schedules.
- Be sure to read and understand *Precautions when servicing your vehicle* in this chapter.

If the engine coolant has not been checked at the recommended interval, the engine coolant reservoir may become low or empty. If the reservoir is low or empty, add engine coolant to the reservoir. Refer to *Adding engine coolant* in this chapter.

Note: Automotive fluids are not interchangeable; do not use engine coolant, antifreeze or windshield washer fluid outside of its specified function and vehicle location.

Adding engine coolant

When adding coolant, make sure it is a 50/50 mixture of engine coolant and distilled water. **When the engine is cool**, add the mixture to the coolant reservoir until the appropriate fill level is obtained.

Maintenance and Specifications



WARNING: Do not add engine coolant when the engine is hot. Steam and scalding liquids released from a hot cooling system can burn you badly. Also, you can be burned if you spill coolant on hot engine parts.



WARNING: Do not put engine coolant in the windshield washer fluid container. If sprayed on the windshield, engine coolant could make it difficult to see through the windshield.

- **Add Motorcraft Premium Gold Engine Coolant or equivalent meeting Ford specification WSS-M97B51-A1.** Refer to *Maintenance product specifications and capacities* in this chapter.

Note: Use of Motorcraft Cooling System Stop Leak Pellets or an equivalent product meeting Ford specification WSS-M99B37-B6, may darken the color of Motorcraft Premium Gold Engine Coolant from yellow to golden tan.

- **Do not add/mix an orange-colored, extended life coolant such as Motorcraft Specialty Orange Engine Coolant, meeting Ford specification WSS-M97B44-D, or DEX-COOL® brand with the factory-filled coolant.** Mixing Motorcraft Specialty Orange Engine Coolant or any orange-colored extended life product such as DEX-COOL® brand with your factory filled coolant can result in degraded corrosion protection.
- A large amount of water without engine coolant may be added, in case of emergency, to reach a vehicle service location. In this instance, the cooling system must be drained and refilled with a 50/50 mixture of engine coolant and distilled water as soon as possible. Water alone (without engine coolant) can cause engine damage from corrosion, overheating or freezing.
- **Do not use alcohol, methanol, brine or any engine coolants mixed with alcohol or methanol antifreeze (coolant).** Alcohol and other liquids can cause engine damage from overheating or freezing.
- **Do not add extra inhibitors or additives to the coolant.** These can be harmful and compromise the corrosion protection of the engine coolant.

For vehicles with overflow coolant systems with a non-pressurized cap on the coolant recovery system, add coolant to the coolant recovery reservoir when the engine is cool. Add the proper mixture of coolant and

Maintenance and Specifications

water to the “FULL COLD” level. For all other vehicles which have a coolant degas system with a pressurized cap, or if it is necessary to remove the coolant pressure relief cap on the radiator of a vehicle with an overflow system, follow these steps to add engine coolant.



WARNING: To reduce the risk of personal injury, make sure the engine is cool before unscrewing the coolant pressure relief cap. The cooling system is under pressure; steam and hot liquid can come out forcefully when the cap is loosened slightly.

Add the proper mixture of coolant and water to the cooling system by following these steps:

1. Before you begin, turn the engine off and let it cool.
2. When the engine is cool, wrap a thick cloth around the coolant pressure relief cap on the coolant reservoir (a translucent plastic bottle). Slowly turn cap counterclockwise (left) until pressure begins to release.
3. Step back while the pressure releases.
4. When you are sure that all the pressure has been released, use the cloth to turn it counterclockwise and remove the cap.
5. Fill the coolant reservoir slowly with the proper coolant mixture, to within the “COLD FILL RANGE” or the “FULL COLD” level on the reservoir. If you removed the radiator cap in an overflow system, fill the radiator until the coolant is visible and radiator is almost full.
6. Replace the cap. Turn until tightly installed. Cap must be tightly installed to prevent coolant loss.

After any coolant has been added, check the coolant concentration (refer to *Checking engine coolant*). If the concentration is not 50/50 (protection to $-34^{\circ}\text{F}/-36^{\circ}\text{C}$), drain some coolant and adjust the concentration. It may take several drains and additions to obtain a 50/50 coolant concentration.

Whenever coolant has been added, the coolant level in the coolant reservoir should be checked the next few times you drive the vehicle. If necessary, add enough 50/50 concentration of engine coolant and distilled water to bring the liquid level to the proper level.

If you have to add more than 1.0 quart (1.0 liter) of engine coolant per month, have your authorized dealer check the engine cooling system. Your cooling system may have a leak. Operating an engine with a low level of coolant can result in engine overheating and possible engine damage.

Maintenance and Specifications

Recycled engine coolant

Ford Motor Company does NOT recommend the use of recycled engine coolant since a Ford-approved recycling process is not yet available.



Used engine coolant should be disposed of in an appropriate manner. Follow your community's regulations and standards for recycling and disposing of automotive fluids.

Coolant refill capacity

To find out how much fluid your vehicle's cooling system can hold, refer to *Maintenance product specifications and capacities* in this chapter.

Fill your engine coolant reservoir as outlined in *Adding engine coolant* in this section.

Severe climates

If you drive in extremely cold climates (less than -34°F [-36°C]):

- **It may be necessary to increase the coolant concentration above 50%.**
- **NEVER increase the coolant concentration above 60%.**
- **Increased engine coolant concentrations above 60% will decrease the overheat protection characteristics of the engine coolant and may cause engine damage.**
- **Refer to the chart on the coolant container to ensure the coolant concentration in your vehicle will provide adequate freeze protection at the temperatures in which you drive in the winter months.**

If you drive in extremely hot climates:

- **It is still necessary to maintain the coolant concentration above 40%.**
- **NEVER decrease the coolant concentration below 40%.**
- **Decreased engine coolant concentrations below 40% will decrease the corrosion protection characteristics of the engine coolant and may cause engine damage.**
- **Decreased engine coolant concentrations below 40% will decrease the freeze protection characteristics of the engine coolant and may cause engine damage.**
- **Refer to the chart on the coolant container to ensure the coolant concentration in your vehicle will provide adequate protection at the temperatures in which you drive.**

Maintenance and Specifications

Vehicles driven year-round in non-extreme climates should use a 50/50 mixture of engine coolant and distilled water for optimum cooling system and engine protection.

What you should know about fail-safe cooling

If the engine coolant supply is depleted, this feature allows the vehicle to be driven temporarily before incremental component damage is incurred. The “fail-safe” distance depends on ambient temperatures, vehicle load and terrain.

How fail-safe cooling works

If the engine begins to overheat:

- The engine coolant temperature gauge will move to the H (hot) area.
- The *Service engine soon* indicator light will illuminate.
- The message center (if equipped) will display COOLANT OVER TEMPERATURE.
- The  symbol will illuminate.

If the engine reaches a preset over-temperature condition, the engine will automatically switch to alternating cylinder operation. Each disabled cylinder acts as an air pump and cools the engine.

When this occurs the vehicle will still operate. However:

- The engine power will be limited.
- The air conditioning system will be disabled.

Continued operation will increase the engine temperature:

- The engine will completely shut down, causing steering and braking effort to increase.

Once the engine temperature cools, the engine can be re-started. Take your vehicle to an authorized dealer as soon as possible to minimize engine damage.

When fail-safe mode is activated

You have limited engine power when in the fail-safe mode, so drive the vehicle with caution. The vehicle will not be able to maintain high-speed operation and the engine will run rough. Remember that the engine is capable of completely shutting down automatically to prevent engine damage, therefore:

1. Pull off the road as soon as safely possible and turn off the engine.
2. Arrange for the vehicle to be taken to an authorized dealer.

Maintenance and Specifications

3. If this is not possible, wait a short period for the engine to cool.
4. Check the coolant level and replenish if low.



WARNING: Never remove the coolant reservoir cap while the engine is running or hot.

5. Re-start the engine and take your vehicle to an authorized dealer.

Driving the vehicle without repairing the engine problem increases the chance of engine damage. Take your vehicle to an authorized dealer as soon as possible.

FUEL FILTER

For fuel filter replacement, see your authorized dealer. Refer to *scheduled maintenance information* for the appropriate intervals for changing the fuel filter.

Replace the fuel filter with an authorized Motorcraft part. The customer warranty may be void for any damage to the fuel system if an authorized Motorcraft fuel filter is not used.

WHAT YOU SHOULD KNOW ABOUT AUTOMOTIVE FUELS

Important safety precautions



WARNING: Do not overfill the fuel tank. The pressure in an overfilled tank may cause leakage and lead to fuel spray and fire.



WARNING: The fuel system may be under pressure. If the fuel filler cap is venting vapor or if you hear a hissing sound, wait until it stops before completely removing the fuel filler cap. Otherwise, fuel may spray out and injure you or others.



WARNING: If you do not use the proper fuel filler cap, excessive vacuum in the fuel tank may damage the fuel system or cause the fuel cap to disengage in a collision, which may result in serious personal injury.



WARNING: Automotive fuels can cause serious injury or death if misused or mishandled.

Maintenance and Specifications



WARNING: Fuel ethanol and gasoline may contain benzene, which is a cancer-causing agent.

Observe the following guidelines when handling automotive fuel:

- Extinguish all smoking materials and any open flames before fueling your vehicle.
- Always turn off the vehicle before fueling.
- Automotive fuels can be harmful or fatal if swallowed. Fuels such as gasoline and ethanol are highly toxic and if swallowed can cause death or permanent injury. If fuel is swallowed, call a physician immediately, even if no symptoms are immediately apparent. The toxic effects of fuel may not be visible for hours.
- Avoid inhaling fuel vapors. Inhaling too much fuel vapor of any kind can lead to eye and respiratory tract irritation. In severe cases, excessive or prolonged breathing of fuel vapor can cause serious illness and permanent injury.
- Avoid getting fuel liquid in your eyes. If fuel is splashed in the eyes, remove contact lenses (if worn), flush with water for 15 minutes and seek medical attention. Failure to seek proper medical attention could lead to permanent injury.
- Fuels can also be harmful if absorbed through the skin. If fuel is splashed on the skin and/or clothing, promptly remove contaminated clothing and wash skin thoroughly with soap and water. Repeated or prolonged skin contact with fuel liquid or vapor causes skin irritation.
- Be particularly careful if you are taking “Antabuse” or other forms of disulfiram for the treatment of alcoholism. Breathing gasoline and/or ethanol vapors, or skin contact could cause an adverse reaction. In sensitive individuals, serious personal injury or sickness may result. If fuel is splashed on the skin, promptly wash skin thoroughly with soap and water. Consult a physician immediately if you experience an adverse reaction.
- FFV fuel tanks may contain zero to 85 percent ethanol. Any fuel blends containing gasoline and ethanol should be treated the same as “Fuel Ethanol.” To identify if your vehicle is an FFV, it may be equipped with a yellow fuel cap with the text “E85/Gasoline”, or check if there is a label on the fuel filler door.



Maintenance and Specifications

Pure ethanol is the alcohol which is the intoxicating agent in liquor, beer and wine. It is distilled from the fermentation of plants such as field corn and sugar cane. When ethanol is produced for use in motor fuels, a small amount of gasoline is added to make it unfit for beverage use. The resulting ethanol blend is called denatured fuel ethanol meaning that it is denatured with 2% to 5% gasoline and is suitable for automotive use.

During the summer season, fuel ethanol may contain a maximum of 85% denatured ethanol (Ed85) and 15% unleaded gasoline. The fuel ethanol has a higher octane rating than unleaded regular or premium gasoline and this allows the design of engines with greater efficiency and power.

Winter blends may contain up to 75% denatured ethanol (Ed75) and up to 25% unleaded gasoline to enhance cold engine starts. Severely cold weather may require additional measures for reliable starting. Refer to *Starting* in the *Driving* chapter.

Ethanol is more chemically active than gasoline. It corrodes some metals and causes some plastic and rubber components to swell, break down or become brittle and crack, especially when mixed with gasoline. Special materials and procedures have been developed for flexible fuel vehicles and the dispensers used by ethanol fuel providers.



WARNING: Flexible fuel components and standard unleaded gasoline fuel components are not interchangeable. If your vehicle is not serviced in accordance with flexible fuel vehicles procedures, damage may occur and your warranty may be invalidated.



WARNING: When refueling always shut the engine off and never allow sparks or open flames near the filler neck. Never smoke while refueling. Fuel vapor is extremely hazardous under certain conditions. Care should be taken to avoid inhaling excess fumes.



WARNING: The flow of fuel through a fuel pump nozzle can produce static electricity, which can cause a fire if fuel is pumped into an ungrounded fuel container.

Maintenance and Specifications

Refueling



WARNING: Fuel vapor burns violently and a fuel fire can cause severe injuries. To help avoid injuries to you and others:

- Read and follow all the instructions on the pump island;
- Turn off your engine when you are refueling;
- Do not smoke if you are near fuel or refueling your vehicle;
- Keep sparks, flames and smoking materials away from fuel;
- Stay outside your vehicle and do not leave the fuel pump unattended when refueling your vehicle — this is against the law in some places;
- Keep children away from the fuel pump; never let children pump fuel.

Use the following guidelines to avoid electrostatic charge build-up when filling an ungrounded fuel container:

- Place approved fuel container on the ground.
- DO NOT fill a fuel container while it is in the vehicle (including the cargo area).
- Keep the fuel pump nozzle in contact with the fuel container while filling.
- DO NOT use a device that would hold the fuel pump handle in the fill position.



Fuel filler cap



When fueling your vehicle:

1. Turn the engine off.
2. Carefully turn the filler cap counterclockwise until it spins off.
3. Pull to remove the cap from the fuel filler pipe.
4. To install the cap, align the tabs on the cap with the notches on the filler pipe.
5. Turn the filler cap clockwise until it clicks at least once.

If the check fuel cap light  or a “check fuel cap” message comes on, the fuel filler cap may not be properly installed. The light or message can come on after several driving events after you’ve refueled your vehicle.

Maintenance and Specifications

At the next opportunity, safely pull off of the road, remove the fuel filler cap, align the cap properly and reinstall it. The check fuel cap light  or “check fuel cap” message may not reset immediately; it may take several driving cycles for the check fuel cap light  or “check fuel cap” message to turn off. A driving cycle consists of an engine start-up (after four or more hours with the engine off) followed by city and highway driving.

Continuing to drive with the check fuel cap light  or “check fuel cap” message on may cause the  light to turn on as well.

If you must replace the fuel filler cap, replace it with a fuel filler cap that is designed for your vehicle. The customer warranty may be void for any damage to the fuel tank or fuel system if the correct genuine Ford, Motorcraft or other certified fuel filler cap is not used.

 **WARNING:** The fuel system may be under pressure. If the fuel filler cap is venting vapor or if you hear a hissing sound, wait until it stops before completely removing the fuel filler cap. Otherwise, fuel may spray out and injure you or others.

 **WARNING:** If you do not use the proper fuel filler cap, excessive vacuum in the fuel tank may damage the fuel system or cause the fuel cap to disengage in a collision, which may result in personal injury.

FFV (Flex Fuel Vehicle) fuel cap

If your vehicle is FFV capable, it will have a yellow colored fuel cap.

FORD RECOMMENDS BP



Maintenance and Specifications

Choosing the right fuel

If your vehicle is a flexible fuel vehicle (FFV), use only UNLEADED FUEL and FUEL ETHANOL (Ed75–Ed85).

If your vehicle is not a flexible fuel vehicle (FFV), then only use UNLEADED fuel or UNLEADED fuel blended with a maximum of 10% ethanol. Do not use fuel ethanol (E85), diesel, methanol, leaded fuel or any other fuel.

The use of leaded fuel is prohibited by law and could damage your vehicle.

Your vehicle was not designed to use fuel or fuel additives with metallic compounds, including manganese-based additives.

Note: Use of any fuel other than those recommended may cause powertrain damage, a loss of vehicle performance, and repairs may not be covered under warranty.

Cleaner air

Ford endorses the use of reformulated “cleaner-burning” gasolines to improve air quality, per the recommendations in the *Choosing the right fuel* section.

Octane recommendations

Do not be concerned if your engine sometimes knocks lightly. However, if it knocks heavily under most driving conditions while you are using fuel with the recommended octane rating, see your authorized dealer to prevent any engine damage.

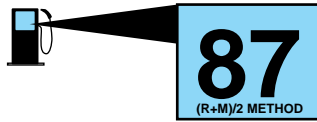

Unleaded Gasoline Engines

Your vehicle is designed to use “Regular” unleaded gasoline with a pump (R+M)/2 octane rating of 87. We do not recommend the use of gasolines labeled as “Regular” in high altitude areas that are sold with octane ratings less than 87.

FFV engine

Your vehicle is designed to use Fuel Ethanol (Ed75–Ed85), “Regular” unleaded gasoline or any mixture of the two fuels.

Use of other fuels such as Fuel Methanol may cause powertrain damage, a loss of vehicle performance, and your warranty may be invalidated.

Maintenance and Specifications

Fuel quality

Do not add aftermarket fuel additive products to your fuel tank. It should not be necessary to add any aftermarket products to your fuel tank if you continue to use high quality fuel of the recommended octane rating. These products have not been approved for your engine and could cause damage to the fuel system. Repairs to correct the effects of using an aftermarket product in your fuel may not be covered by your warranty.

Many of the world's automakers approved the World-Wide Fuel Charter that recommends gasoline specifications to provide improved performance and emission control system protection for your vehicle. Gasolines that meet the World-Wide Fuel Charter should be used when available. Ask your fuel supplier about gasolines that meet the World-Wide Fuel Charter.

Unleaded gasoline engines

If you are experiencing starting, rough idle or hesitation driveability problems during a cold start, try a different brand of "Regular" unleaded gasoline. "Premium" unleaded gasoline is not recommended for vehicles designed to use "Regular" unleaded gasoline because it may cause these problems to become more pronounced. If the problems persist, see your authorized dealer.

FFV engine (if equipped)

To identify if your vehicle is an FFV, it may be equipped with a yellow fuel cap with the text "E85/Gasoline", or check if there is a label on the fuel filler door.

It is best not to alternate repeatedly between gasoline and E85. If you do switch fuels, it is recommended that you add as much fuel as possible—at least half a tank. Do not add less than five gallons (18.9 L) when refueling. You should drive the vehicle immediately after refueling for at least 5 miles (8 km) to allow the vehicle to adapt to the change in ethanol concentration.



If you operate your vehicle 50% or more of the time on ethanol, you should follow a different maintenance schedule. In addition to this, if you exclusively use E85 fuel, it is also recommended to fill the fuel tank with regular unleaded gasoline once every 3,000 miles (4,800 km). See *scheduled maintenance information* for more information.

Running out of fuel

Avoid running out of fuel because this situation may have an adverse effect on powertrain components.

Maintenance and Specifications

If you have run out of fuel:

- You may need to cycle the ignition from off to on several times after refueling to allow the fuel system to pump the fuel from the tank to the engine. On restarting, cranking time will take a few seconds longer than normal.
- Normally, adding 1 gallon (3.8L) of fuel is enough to restart the engine. If the vehicle is out of fuel and on a steep grade, more than 1 gallon (3.8L) may be required.
- The service engine soon  indicator may come on. For more information on the service engine soon  indicator, refer to *Warning lights and chimes* in the *Instrument Cluster* chapter.

ESSENTIALS OF GOOD FUEL ECONOMY

Measuring techniques

Your best source of information about actual fuel economy is you, the driver. You must gather information as accurately and consistently as possible. Fuel expense, frequency of fill-ups or fuel gauge readings are NOT accurate as a measure of fuel economy. We do not recommend taking fuel economy measurements during the first 1,000 miles (1,600 km) of driving (engine break-in period). You will get a more accurate measurement after 2,000 miles–3,000 miles (3,000 km–5,000 km).

Filling the tank

The advertised fuel capacity of the fuel tank on your vehicle is equal to the rated refill capacity of the fuel tank as listed in the *Maintenance product specifications and capacities* section of this chapter.

The advertised capacity is the amount of the indicated capacity and the empty reserve combined. Indicated capacity is the difference in the amount of fuel in a full tank and a tank when the fuel gauge indicates empty. Empty reserve is the small amount of fuel remaining in the fuel tank after the fuel gauge indicates empty.

The amount of usable fuel in the empty reserve varies and should not be relied upon to increase driving range. When refueling your vehicle after the fuel gauge indicates empty, you might not be able to refuel the full amount of the advertised capacity of the fuel tank due to the empty reserve still present in the tank.

For consistent results when filling the fuel tank:

- Turn the engine/ignition switch to the off position prior to refueling, an error in the reading will result if the engine is left running.

Maintenance and Specifications

- Use the same filling rate setting (low — medium — high) each time the tank is filled.
- Allow no more than two automatic click-offs when filling.
- Always use fuel with the recommended octane rating.
- Use a known quality gasoline, preferably a national brand.
- Use the same side of the same pump and have the vehicle facing the same direction each time you fill up.
- Have the vehicle loading and distribution the same every time.

Your results will be most accurate if your filling method is consistent.

Calculating fuel economy

1. Fill the fuel tank completely and record the initial odometer reading (in miles or kilometers).
2. Each time you fill the tank, record the amount of fuel added (in gallons or liters).
3. After at least three to five tank fill-ups, fill the fuel tank and record the current odometer reading.
4. Subtract your initial odometer reading from the current odometer reading.
5. Follow one of the simple calculations in order to determine fuel economy:

Calculation 1: **Divide total miles traveled by total gallons used.**

Calculation 2: **Multiply liters used by 100, then divide by total kilometers traveled.**

Keep a record for at least one month and record the type of driving (city or highway). This will provide an accurate estimate of the vehicle's fuel economy under current driving conditions. Additionally, keeping records during summer and winter will show how temperature impacts fuel economy. In general, lower temperatures give lower fuel economy.

Driving style — good driving and fuel economy habits

Give consideration to the lists that follow and you may be able to change a number of variables and improve your fuel economy.

Habits

- Smooth, moderate operation can yield up to 10% savings in fuel.
- Steady speeds without stopping will usually give the best fuel economy.

Maintenance and Specifications

- Idling for long periods of time (greater than one minute) may waste fuel.
- Anticipate stopping; slowing down may eliminate the need to stop.
- Sudden or hard accelerations may reduce fuel economy.
- Slow down gradually.
- Driving at reasonable speeds (traveling at 55 mph [88 km/h] uses 15% less fuel than traveling at 65 mph [105 km/h]).
- Revving the engine before turning it off may reduce fuel economy.
- Using the air conditioner or defroster may reduce fuel economy.
- You may want to turn off the speed control in hilly terrain if unnecessary shifting between the top gears occurs. Unnecessary shifting of this type could result in reduced fuel economy.
- Warming up a vehicle on cold mornings is not required and may reduce fuel economy.
- Resting your foot on the brake pedal while driving may reduce fuel economy.
- Combine errands and minimize stop-and-go driving.

Maintenance

- Keep tires properly inflated and use only recommended size.
- Operating a vehicle with the wheels out of alignment will reduce fuel economy.
- Use recommended engine oil. Refer to *Maintenance product specifications and capacities* in this chapter.
- Perform all regularly scheduled maintenance items. Follow the recommended maintenance schedule and owner maintenance checks found in *scheduled maintenance information*.

Conditions

- Heavily loading a vehicle or towing a trailer may reduce fuel economy at any speed.
- Carrying unnecessary weight may reduce fuel economy (approximately 1 mpg [0.4 km/L] is lost for every 400 lb [180 kg] of weight carried).
- Adding certain accessories to your vehicle (for example bug deflectors, rollbars/light bars, running boards, ski racks) may reduce fuel economy.
- Using fuel blended with alcohol may lower fuel economy.

Maintenance and Specifications

- Fuel economy may decrease with lower temperatures during the first 8–10 miles (12–16 km) of driving.
- Driving on flat terrain offers improved fuel economy as compared to driving on hilly terrain.
- Transmissions give their best fuel economy when operated in the top cruise gear and with steady pressure on the gas pedal.
- Close windows for high speed driving.

EPA fuel economy estimates

Every new vehicle should have a window sticker containing EPA fuel economy estimates. Contact your authorized dealer if the window sticker is not supplied with your vehicle. The EPA fuel economy estimates should be your guide for the fuel economy comparisons with other vehicles. Your fuel economy may vary depending upon the method of operation and conditions.

EMISSION CONTROL SYSTEM

Your vehicle is equipped with various emission control components and a catalytic converter which will enable your vehicle to comply with applicable exhaust emission standards. To make sure that the catalytic converter and other emission control components continue to work properly:

- Use only the specified fuel listed.
- Avoid running out of fuel.
- Do not turn off the ignition while your vehicle is moving, especially at high speeds.
- Have the items listed in *scheduled maintenance information* performed according to the specified schedule.

The scheduled maintenance items listed in *scheduled maintenance information* are essential to the life and performance of your vehicle and to its emissions system.

If other than Ford, Motorcraft or Ford-authorized parts are used for maintenance replacements or for service of components affecting emission control, such non-Ford parts should be equivalent to genuine Ford Motor Company parts in performance and durability.



WARNING: Do not park, idle, or drive your vehicle in dry grass or other dry ground cover. The emission system heats up the engine compartment and exhaust system, which can start a fire.

Maintenance and Specifications

Illumination of the service engine soon  indicator, charging system warning light or the temperature warning light, fluid leaks, strange odors, smoke or loss of engine power could indicate that the emission control system is not working properly.

An improperly operating or damaged exhaust system may allow exhaust to enter the vehicle. Have a damaged or improperly operating exhaust system inspected and repaired immediately.





WARNING: Exhaust leaks may result in entry of harmful and potentially lethal fumes into the passenger compartment.

Do not make any unauthorized changes to your vehicle or engine. By law, vehicle owners and anyone who manufactures, repairs, services, sells, leases, trades vehicles, or supervises a fleet of vehicles are not permitted to intentionally remove an emission control device or prevent it from working. Information about your vehicle's emission system is on the Vehicle Emission Control Information Decal located on or near the engine. This decal also lists engine displacement.

Please consult your *Warranty Guide/Customer Information Guide* for complete emission warranty information.

On board diagnostics (OBD-II)



Your vehicle is equipped with a computer that monitors the engine's emission control system. This system is commonly known as the On Board Diagnostics System (OBD-II). The OBD-II system protects the environment by ensuring that your vehicle continues to meet government emission standards. The OBD-II system also assists your authorized dealer in properly servicing your vehicle. When the service engine soon  indicator illuminates, the OBD-II system has detected a malfunction. Temporary malfunctions may cause the service engine soon  indicator to illuminate. Examples are:

1. The vehicle has run out of fuel—the engine may misfire or run poorly.
2. Poor fuel quality or water in the fuel—the engine may misfire or run poorly.
3. The fuel cap may not have been securely tightened. See *Fuel filler cap* in this chapter.
4. Driving through deep water—the electrical system may be wet.

These temporary malfunctions can be corrected by filling the fuel tank with good quality fuel, properly tightening the fuel cap or letting the

Maintenance and Specifications



electrical system dry out. After three driving cycles without these or any other temporary malfunctions present, the service engine soon  indicator should stay off the next time the engine is started. A driving cycle consists of a cold engine startup followed by mixed city/highway driving. No additional vehicle service is required.

If the service engine soon  indicator remains on, have your vehicle serviced at the first available opportunity. Although some malfunctions detected by the OBD-II may not have symptoms that are apparent, continued driving with the service engine soon  indicator on can result in increased emissions, lower fuel economy, reduced engine and transmission smoothness, and lead to more costly repairs.

Readiness for Inspection/Maintenance (I/M) testing

Some state/provincial and local governments may have Inspection/Maintenance (I/M) programs to inspect the emission control equipment on your vehicle. Failure to pass this inspection could prevent you from getting a vehicle registration. Your vehicle may not pass the I/M test if the service engine soon  indicator is on or not working properly (bulb is burned out), or if the OBD-II system has determined that some of the emission control systems have not been properly checked. In this case, the vehicle is considered not ready for I/M testing.

If the service engine soon  indicator is on or the bulb does not work, the vehicle may need to be serviced. Refer to the On board diagnostics (OBD-II) description in this chapter.

If the vehicle's engine or transmission has just been serviced, or the battery has recently run down or been replaced, the OBD-II system may indicate that the vehicle is not ready for I/M testing. To determine if the vehicle is ready for I/M testing, turn the ignition key to the on position for 15 seconds without cranking the engine. If the service engine soon  indicator blinks eight times, it means that the vehicle is not ready for I/M testing; if the service engine soon  indicator stays on solid, it means that the vehicle is ready for I/M testing.

The OBD-II system is designed to check the emission control system during normal driving. A complete check may take several days. If the vehicle is not ready for I/M testing, the following driving cycle consisting of mixed city and highway driving may be performed:

15 minutes of steady driving on an expressway/highway followed by 20 minutes of stop-and-go driving with at least four 30-second idle periods.

Maintenance and Specifications

Allow the vehicle to sit for at least eight hours without starting the engine. Then, start the engine and complete the above driving cycle. The engine must warm up to its normal operating temperature. Once started, do not turn off the engine until the above driving cycle is complete. If the vehicle is still not ready for I/M testing, the above driving cycle will have to be repeated.

POWER STEERING FLUID

Check the power steering fluid.
Refer to *scheduled maintenance information*.

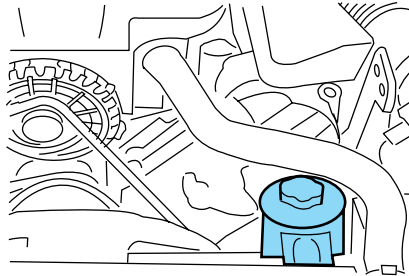

1. Start the engine and let it run until it reaches normal operating temperature (the engine coolant temperature gauge indicator will be near the center of the normal area between H and C).
2. While the engine idles, turn the steering wheel left and right several times.
3. Turn the engine off.
4. Check the fluid level in the reservoir. It should be between the MIN and MAX lines. Do not add fluid if the level is in this range.

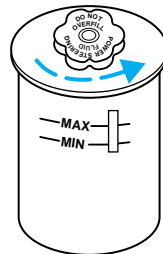

5. If the fluid is low, add fluid in small amounts, continuously checking the level until it reaches the range between the MIN and MAX lines. Be sure to put the cap back on the reservoir. Refer to *Maintenance product specifications and capacities* in this chapter for the proper fluid type.

Maintenance and Specifications

BRAKE FLUID

The fluid level will drop slowly as the brakes wear, and will rise when the brake components are replaced. Fluid levels below the “MAX” line that do not trigger the brake system warning lamp are within the normal operating range, there is no need to add fluid. If the fluid levels are outside of the normal operating range, the performance of your brake system could be compromised, seek service from your authorized dealer immediately.

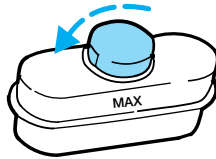

TRANSMISSION FLUID

Checking automatic transmission fluid (if equipped)

Refer to your *scheduled maintenance information* for scheduled intervals for fluid checks and changes. Your transmission does not consume fluid. However, the fluid level should be checked if the transmission is not working properly, i.e., if the transmission slips or shifts slowly or if you notice some sign of fluid leakage.

Automatic transmission fluid expands when warmed. To obtain an accurate fluid check, drive the vehicle until it is at normal operating temperature (approximately 20 miles [30 km]). If your vehicle has been operated for an extended period at high speeds, in city traffic during hot weather or pulling a trailer, the vehicle should be turned off for about 30 minutes to allow fluid to cool before checking.

1. Drive the vehicle 20 miles (30 km) or until it reaches normal operating temperature.
2. Park the vehicle on a level surface and engage the parking brake.
3. With the parking brake engaged and your foot on the brake pedal, start the engine and move the gearshift lever through all of the gear ranges. Allow sufficient time for each gear to engage.
4. Latch the gearshift lever in P (Park) and leave the engine running.
5. Remove the dipstick, wiping it clean with a clean, dry lint free rag. If necessary, refer to *Identifying components in the engine compartment* in this chapter for the location of the dipstick.
6. Install the dipstick making sure it is fully seated in the filler tube.
7. Remove the dipstick and inspect the fluid level. The fluid should be in the designated area for normal operating temperature or ambient temperature.

Maintenance and Specifications

Low fluid level

Do not drive the vehicle if the fluid level is at the bottom of the dipstick and the ambient temperature is above 50°F (10°C).

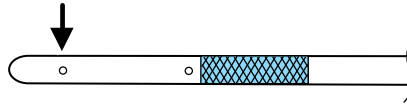

Correct fluid level

The transmission fluid should be checked at normal operating temperature 150°F-170°F (66°C-77°C) on a level surface. The normal operating temperature can be reached after approximately 20 miles (30 km) of driving.

You can check the fluid without driving if the ambient temperature is above 50°F (10°C). However, if fluid is added at this time, an overfill condition could result when the vehicle reaches normal operating temperature.

The transmission fluid should be in this range if at normal operating temperature (150°F-170°F [66°C-77°C]).

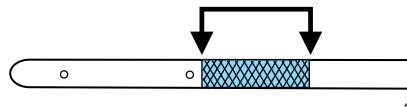

The transmission fluid should be in this range if at ambient temperature (50°F-95°F [10°C-35°C]).

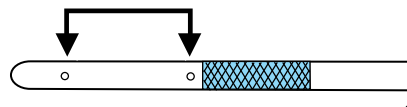

High fluid level

Fluid levels above the safe range may result in transmission failure. An overfill condition of transmission fluid may cause shift and/or engagement concerns and/or possible damage.

High fluid levels can be caused by an overheating condition.

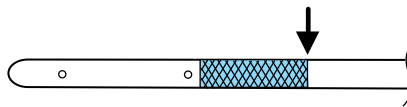

Adjusting automatic transmission fluid levels

Before adding any fluid, make sure the correct type is used. The type of fluid used is normally indicated on the dipstick. Refer to *Maintenance product specifications and capacities* in this chapter.

Maintenance and Specifications

Use of a non-approved automatic transmission fluid may cause internal transmission component damage.

If necessary, add fluid in 1/2 pint (250 ml) increments through the filler tube until the level is correct.

If an overfill occurs, excess fluid should be removed by an authorized dealer.

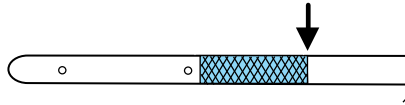

An overfill condition of transmission fluid may cause shift and/or engagement concerns and/or possible damage.

Do not use supplemental transmission fluid additives, treatments or cleaning agents. The use of these materials may affect transmission operation and result in damage to internal transmission components.

AIR FILTER

Refer to *scheduled maintenance information* for the appropriate intervals for changing the air filter element.

When changing the air filter element, use only the air filter element listed. Refer to *Motorcraft part numbers* in this chapter.



WARNING: To reduce the risk of vehicle damage and/or personal burn injuries do not start your engine with the air cleaner removed and do not remove it while the engine is running.

Changing the air filter element

1. Release the clamps that secure the air filter housing cover.
2. Carefully separate the two halves of the air filter housing.
3. Remove the air filter element from the air filter housing.
4. Wipe the air filter housing and cover clean to remove any dirt or debris and to ensure good sealing.

Maintenance and Specifications

5. Install a new air filter element. Be careful not to crimp the filter element edges between the air filter housing and cover. This could cause filter damage and allow unfiltered air to enter the engine if not properly seated.

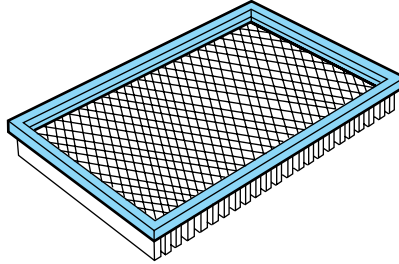

6. Replace the air filter housing cover and secure the clamps.

7. Replace the air inlet tube and secure the clamp.

Note: Be sure the hinge features of the air filter cover to the air filter housing are fully engaged when reassembling the air filter assembly.

Note: Failure to use the correct air filter element may result in severe engine damage. The customer warranty may be void for any damage to the engine if the correct air filter element is not used.

MOTORCRAFT PART NUMBERS

Component	4.6L SOHC V8 engine
Air filter element	FA-1783
Fuel filter	FG-1114
Battery-standard	BXT-65-650
Battery-heavy duty	BXT-65-750
Oil filter	FL-820-S
Oil filter (with oil cooler)	FL-820-S (FL-910 late availability)
PCV valve	1
Spark plugs	2

¹The PCV valve is a critical emission component. It is one of the items listed in *scheduled maintenance information* and is essential to the life and performance of your vehicle and to its emissions system.

For PCV valve replacement, see your authorized dealer. Refer to *scheduled maintenance information* for the appropriate intervals for changing the PCV valve.

Maintenance and Specifications

Replace the PCV valve with one that meets Ford material and design specifications for your vehicle, such as a Motorcraft or equivalent replacement part. The customer warranty may be void for any damage to the emissions system if such a PCV valve is not used.

²For spark plug replacement, see your authorized dealer. Refer to *scheduled maintenance information* for the appropriate intervals for changing the spark plugs.

Replace the spark plugs with ones that meet Ford material and design specifications for your vehicle, such as Motorcraft or equivalent replacement parts. The customer warranty may be void for any damage to the engine if such spark plugs are not used.

Maintenance and Specifications

MAINTENANCE PRODUCT SPECIFICATIONS AND CAPACITIES

Item	Capacity	Ford part name	Ford part number / Ford specification
Brake fluid	Between MIN and MAX on reservoir	Motorcraft High Performance DOT 3 Motor Vehicle Brake Fluid	PM-1-C / WSS-M6C62-A or WSS-M6C65-A1
Door weatherstrips	—	Silicone Spray Lubricant	XL-6 / ESR-M13P4-A
Engine coolant	18.6 quarts (17.6L)	Motorcraft Premium Gold Engine Coolant with bittering agent (yellow-colored) ¹	VC-7-B / WSS-M97B51-A1
Cooling system stop leak pellets	—	Motorcraft Cooling System Stop Leak Pellets	VC-6 / WSS-M99B37-B6
Engine oil	6.0 quarts (5.7L)	Motorcraft SAE 5W-20 Premium Synthetic Blend Motor Oil (US) Motorcraft SAE 5W-20 Super Premium Motor Oil (Canada) ²	XO-5W20-QSP (US) CXO-5W20-LSP12 (Canada) / WSS-M2C930-A with API Certification Mark

Maintenance and Specifications

Item	Capacity	Ford part name	Ford part number / Ford specification
Hinges, latches, striker plates, fuel filler door hinge and seat tracks	—	Multi-Purpose Grease	XG-4 or XL-5 / ESB-M1C93-B
Lock cylinders	—	Motorcraft Penetrating and Lock Lubricant	XL-1 / None
Power steering fluid	Between MIN and MAX on reservoir	Motorcraft MERCON® V ATF	XT-5-QM / MERCON® V
Automatic transmission fluid (4R75E)	13.9 quarts (13.2L) ³	Motorcraft MERCON® LV ATF ⁴	XT-10-QJV / MERCON® LV
Rear axle fluid ⁵	5.0 pints (2.4L) ^{6,7}	Motorcraft SAE 80W-90 Premium Rear Axle Lubricant	XY-80W90-QL / WSP-M2C197-A
Rear axle fluid (Police) ⁵		Motorcraft SAE 75W-140 Synthetic Rear Axle Lubricant	XY-75W140-QL / WSL-M2C192-A
Windshield washer fluid	Fill to line on reservoir	Motorcraft Premium Windshield Washer Concentrate	ZC-32-A / WSB-M8B16-A2

Maintenance and Specifications

Item	Capacity	Ford part name	Ford part number / Ford specification
Fuel tank	19.0 gallons (71.9L)	—	—

¹Add the coolant type originally equipped in your vehicle.

²Use of synthetic or synthetic blend motor oil is not mandatory. Engine oil need only meet the requirements of Ford specification WSS-M2C930-A and the API Certification mark.

³Indicates only approximate dry-fill capacity. Some applications may vary based on cooler size and if equipped with an in-tank cooler. The amount of transmission fluid and fluid level should be set by the indication on the dipstick's normal operating range. Police or Handling Package refill capacity- 12.8 quarts (12.1L).

⁴Use of any fluid other than the recommended fluid may cause transmission damage. Refer to *scheduled maintenance information* to determine the correct service interval.

⁵Rear axles are considered lubricated for life when the vehicle is used for normal service. For severe duty requirements, see *Exceptions and / or Special Operating Conditions* in *scheduled maintenance information*.

⁶Service refill capacities are determined by filling the rear axle 1/4 inch to 9/16 inch (6 mm to 14 mm) below the bottom of the filler hole.

⁷Add 4 oz. (118 ml) of Additive Friction Modifier XL-3 or equivalent meeting Ford specification EST-M2C118-A for complete refill of Traction-Lok rear axles.

Maintenance and Specifications

ENGINE DATA

Engine	4.6L V8 engine	4.6L FFV V8 engine
Cubic inches	281	281
Required fuel	87 octane	87 octane or Ethanol (E 85)
Firing order	1-3-7-2-6-5-4-8	1-3-7-2-6-5-4-8
Ignition system	Coil on plug	Coil on plug
Spark plug gap	0.052–0.056 inch (1.32–1.42 mm)	0.041–0.047 inch (1.04–1.20 mm)
Compression ratio	9.4:1	9.4:1

Engine drivebelt routing

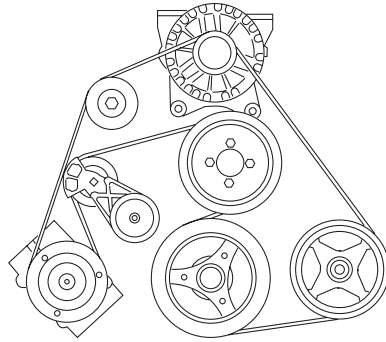

Maintenance and Specifications

IDENTIFYING YOUR VEHICLE

Safety Compliance Certification Label

The National Highway Traffic Safety Administration Regulations require that a Safety Compliance Certification Label be affixed to a vehicle and prescribe where the Safety Compliance Certification Label may be located. The Safety Compliance Certification Label is located on the structure (B-Pillar) by the trailing edge of the driver's door or the edge of the driver's door.

MFD. BY FORD MOTOR CO.			
DATE: XX/XX	GVWR: XXXXLB/ XXXXKG		
FRONT GAWR: XXXXL	REAR GAWR: XXXXLB		
XXXXKG	WITH	XXXXKG	WITH
XXXX/XXXXXX	TIRES	XXXX/XXXXXX	TIRES
XXXX.XX	RIMS	XXXX.XX	RIMS
AT XXX kPa/XX	PSI COLD	AT XXX kPa/XX	PSI COLD
THIS VEHICLE CONFORMS TO ALL APPLICABLE FEDERAL MOTOR VEHICLE SAFETY AND THEFT PREVENTION STANDARDS IN EFFECT ON THE DATE OF MANUFACTURE SHOWN ABOVE.			
VIN: XXXXXXXXXXXXXXXXX	XXXXX XXXXX		
TYPE: XXX			
			
EXT PNT: XX	RC: XX	DSO:	
WB BRK INT TR TP/PS R AXLE TR SPR XXXXX			
XXX X XX X XX X XX XXX			
XXXXXXXXXXXX XXX XXXX-XXXXXX-XX			

Vehicle identification number (VIN)

The vehicle identification number is located on the driver side instrument panel.

Please note that in the graphic, XXXX is representative of your vehicle identification number.

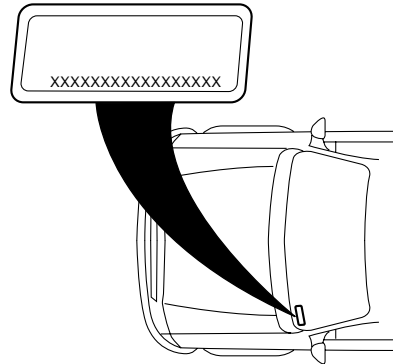

Maintenance and Specifications

The Vehicle Identification Number (VIN) contains the following information:

1. World manufacturer identifier
2. Brake system / Gross Vehicle Weight Rating (GVWR) / Restraint System
3. Vehicle line, series, body type
4. Engine type
5. Check digit
6. Model year
7. Assembly plant
8. Production sequence number

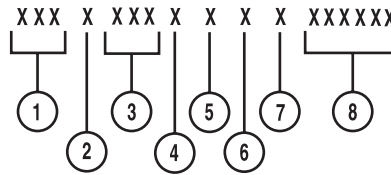

TRANSMISSION CODE DESIGNATIONS

You can find a transmission code on the Safety Compliance Certification Label. The following table tells you which transmission each code represents.

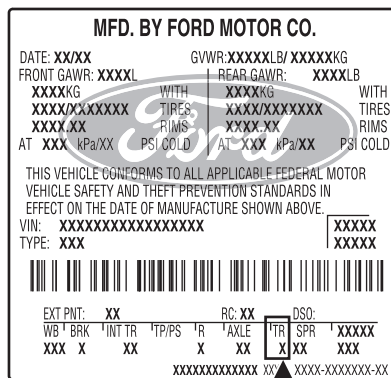

Description	Code
Four-speed automatic overdrive (4R75E)	Q

Accessories

GENUINE FORD ACCESSORIES FOR YOUR VEHICLE

A wide selection of Genuine Ford Accessories are available for your vehicle through your local Ford or Ford of Canada dealer. These quality accessories have been specifically engineered to fulfill your automotive needs; they are custom designed to complement the style and aerodynamic appearance of your vehicle. In addition, each accessory is made from high quality materials and meets or exceeds Ford's rigorous engineering and safety specifications. Ford Motor Company will repair or replace any properly dealer-installed Genuine Ford Accessories found to be defective in factory-supplied materials or workmanship during the warranty period, as well as any component damaged by the defective accessories. The accessories will be warranted for whichever provides you the greatest benefit:

- 12 months or 12,000 miles (20,000 km) (whichever occurs first), or
- the remainder of your new vehicle limited warranty.

Contact your dealer for details and a copy of the warranty.

The following is a list of several Genuine Ford Accessories. Not all accessories are available for all models. For a complete listing of the accessories that are available for your vehicle, please contact your dealer or visit our online store at: www.fordaccessories.com.

Exterior style

Side window deflectors

Splash guards

Spoiler

Interior style

Electrochromatic compass/temperature interior mirrors

Floor mats

Lifestyle

Cargo organization and management

Accessories

Peace of mind

Remote start

Vehicle security systems

For maximum vehicle performance, keep the following information in mind when adding accessories or equipment to your vehicle:

- When adding accessories, equipment, passengers and luggage to your vehicle, do not exceed the total weight capacity of the vehicle or of the front or rear axle (GVWR or GAWR as indicated on the Safety Compliance Certification label). Consult your authorized dealer for specific weight information.
- The Federal Communications Commission (FCC) and Canadian Radio Telecommunications Commission (CRTC) regulate the use of mobile communications systems — such as two-way radios, telephones and theft alarms - that are equipped with radio transmitters. Any such equipment installed in your vehicle should comply with FCC or CRTC regulations and should be installed only by a qualified service technician.
- Mobile communications systems may harm the operation of your vehicle, particularly if they are not properly designed for automotive use.
- To avoid interference with other vehicle functions, such as anti-lock braking systems, amateur radio users who install radios and antennas onto their vehicle should not locate the Amateur Radio Antennas in the area of the driver's side hood.
- Electrical or electronic accessories or components that are added to the vehicle by the authorized dealer or the owner may adversely affect battery performance and durability.

Index

A

ABS (see Brakes)174
Air cleaner filter255–256
Air conditioning38
Air suspension178
description178
Airbag supplemental restraint
system107, 117
and child safety seats109
description107, 117
disposal120
driver airbag110, 118
indicator light117, 119
operation110, 118
passenger airbag110, 118
side airbag117
Antifreeze
(see Engine coolant)233
Anti-lock brake system
(see Brakes)174–175
Anti-theft system83
Audio system
(see Radio)20, 22, 25, 30
Automatic transmission
driving an automatic
overdrive180
fluid, adding253
fluid, checking253
fluid, refill capacities258
fluid, specification258
Auxiliary power point55
Axle
lubricant specifications258
refill capacities258
traction lok179

B

Battery231

266

acid, treating emergencies231
jumping a disabled battery202
maintenance-free231
replacement, specifications256
servicing231
Belt-Minder®103
Booster seats134
Brakes173–174
anti-lock174–175
anti-lock brake system (ABS)
warning light175
fluid, checking and adding253
fluid, refill capacities258
fluid, specifications258
lubricant specifications258
shift interlock179
Bulbs46

C

Capacities for refilling fluids258
Cell phone use8
Child safety seats124
attaching with tether straps132
in front seat125
in rear seat125, 128
LATCH129
recommendations122
Child safety seats - booster
seats134
Cleaning your vehicle
engine compartment219
instrument panel221
interior221
plastic parts220
washing217
waxing218
wheels218
wiper blades220

<https://www.MyCarManual.com>

Index

- Climate control (see Air conditioning or Heating)38
- Clock adjust
6-CD in dash33
AM/FM21
AM/FM/CD24
AM/FM/Tape/CD28
- Console55
- Controls
power seat90
steering column62
- Coolant
checking and adding233
refill capacities237, 258
specifications258
- Cruise control
(see Speed control)59
- Cupholder(s)93
- Customer Assistance184
Ford Extended Service Plan214
Getting assistance outside the U.S. and Canada214
Getting roadside assistance ...184
Getting the service you need210
Ordering additional owner's literature215
Utilizing the Mediation/Arbitration Program213
- D**
- Daytime running lamps
(see Lamps)42
- Defrost
rear window40
- Dipstick
automatic transmission fluid253
engine oil228
- Driving under special conditions182
through water183
- E**
- Electronic message center63
- Emergencies, roadside
jump-starting202
- Emission control system249
- Engine261
cleaning219
coolant233
fail-safe cooling238
idle speed control231
lubrication specifications258
refill capacities258
service points226-227
starting after a collision186
- Engine block heater172
- Engine oil228
change oil soon warning, message center228
checking and adding228
dipstick228
filter, specifications230, 256
recommendations230
refill capacities258
specifications258
- Event data recording7
- Exhaust fumes171
- F**
- Fail safe cooling238
- Flexible Fuel Vehicle (FFV)239

Index

- Floor mats72
- Fluid capacities258
- Fuel239
- calculating fuel
 - economy65, 246
 - cap242
 - capacity258
 - choosing the right fuel244
 - comparisons with EPA fuel
 - economy estimates249
 - detergent in fuel244
 - filling your vehicle with fuel239, 242, 246
 - filter, specifications239, 256
 - fuel pump shut-off switch186
 - improving fuel economy246
 - octane rating244, 261
 - quality245
 - running out of fuel245
 - safety information relating to automotive fuels239
- Fuel - flex fuel vehicle (FFV)239, 244
- Fuses187–188
- G**
- Gas cap (see Fuel cap)242
- Gas mileage (see Fuel economy)246
- Gauges17
- H**
- Hazard flashers185
- Head restraints88
- Headlamps41
- aiming43
 - autolamp system41
 - bulb specifications46
 - daytime running lights42
 - flash to pass42
 - high beam42
 - replacing bulbs47
 - turning on and off41
- Heating
- heating and air conditioning system37–38
- Hood225
- I**
- Ignition168, 261
- Illuminated visor mirror54
- Infant seats (see Safety seats)124
- Inspection/maintenance (I/M) testing251
- Instrument panel
- cleaning221
 - cluster12
 - lighting up panel and interior43
- J**
- Jump-starting your vehicle202
- K**
- Keyless entry system81
- autolock73
 - keypad81
 - programming entry code81
- Keys73, 85–86
- positions of the ignition168

Index

L

- Lamps
 - autolamp system41
 - bulb replacement
 - specifications chart46
 - daytime running light42
 - headlamps41
 - headlamps, flash to pass42
 - instrument panel, dimming43
 - interior lamps45–47
 - replacing bulbs47
- LATCH anchors129
- Lights, warning and indicator12
 - anti-lock brakes (ABS)175
- Limited slip axle
(see Traction Loc)179
- Load limits158
- Locks
 - autolock73
 - childproof75
 - doors73
- Lubricant specifications258
- Lug nuts201
- Lumbar support, seats92

M

- Message center63–64
 - english/metric button68
 - system check button67
 - warning messages69
- Mirrors57–58
 - automatic dimming rearview
 - mirror57
 - fold away58
 - heated58
 - side view mirrors (power)58
- Motorcraft parts223, 239, 256

O

- Octane rating244
- Oil (see Engine oil)228

P

- Parking brake176
- Parts (see Motorcraft parts)256
- Passenger Occupant
Classification Sensor95
- Pedals (see Power adjustable
foot pedals)59
- Power adjustable foot pedals59
- Power distribution box
(see Fuses)191
- Power door locks73
- Power mirrors58
- Power point55
- Power steering178
 - fluid, checking and adding252
 - fluid, refill capacity258
- Power Windows56

R

- Radio20, 22, 25, 30
- Rear window defroster40
- Recommendations for
attaching safety restraints for
children122
- Relays187, 195
- Remote entry system77
 - illuminated entry80
 - locking/unlocking doors78
 - opening the trunk78
 - panic alarm78

Index

- replacement/additional transmitters79
- replacing the batteries78
- Roadside assistance184
- S**
- Safety belts (see Safety restraints)93, 97–102
- Safety Canopy117
- Safety defects, reporting216
- Safety restraints93, 97–102
 - Belt-Minder®103
 - extension assembly101
 - for adults98–101
 - for children120
 - lap belt99
 - Occupant Classification Sensor95
 - warning light and chime102
- Safety restraints - LATCH anchors129
- Safety seats for children124
- Safety Compliance Certification Label262
- Seats88
 - child safety seats124
 - front seats88
- SecuriLock passive anti-theft system83, 86
- Servicing your vehicle224
- Setting the clock
 - AM/FM single CD24
 - AM/FM stereo21
 - AM/FM/In-dash 6 CD33
 - AM/FM/Tape/CD28
- Spark plugs, specifications256, 261
- Specification chart, lubricants258
- Speed control59
- Starting a flex fuel vehicle170
- Starting your vehicle168–170
 - jump starting202
- Steering wheel
 - controls62
 - tilting54
- T**
- Tilt steering wheel54
- Tire Pressure Monitoring System (TPMS)
 - Tires, Wheels and Loading153
- Tires138–139
 - alignment146
 - care142
 - changing199
 - checking the pressure142
 - inflating140
 - label152
 - replacing144
 - rotating146
 - safety practices145
 - sidewall information147
 - snow tires and chains158
 - spare tire196, 198
 - terminology139
 - tire grades139
 - treadwear138, 143
- Towing164
 - recreational towing167
 - trailer towing164
 - wrecker208
- Traction control177
- Traction-lok rear axle179
- Transmission179

Index

- brake-shift interlock (BSI)179
- fluid, checking and adding
(automatic)253
- fluid, refill capacities258
- lubricant specifications258
- Trunk75
- remote release72, 78
- Turn signal45
- V**
- Vehicle Identification Number
(VIN)262
- Vehicle loading158
- Ventilating your vehicle171
- W**
- Warning lights (see Lights)12
- Washer fluid227
- Water, Driving through183
- Windows
- power56
- Windshield washer fluid and
wipers53
- checking and adding fluid227
- replacing wiper blades227
- Wrecker towing208